

# Gigi the cat

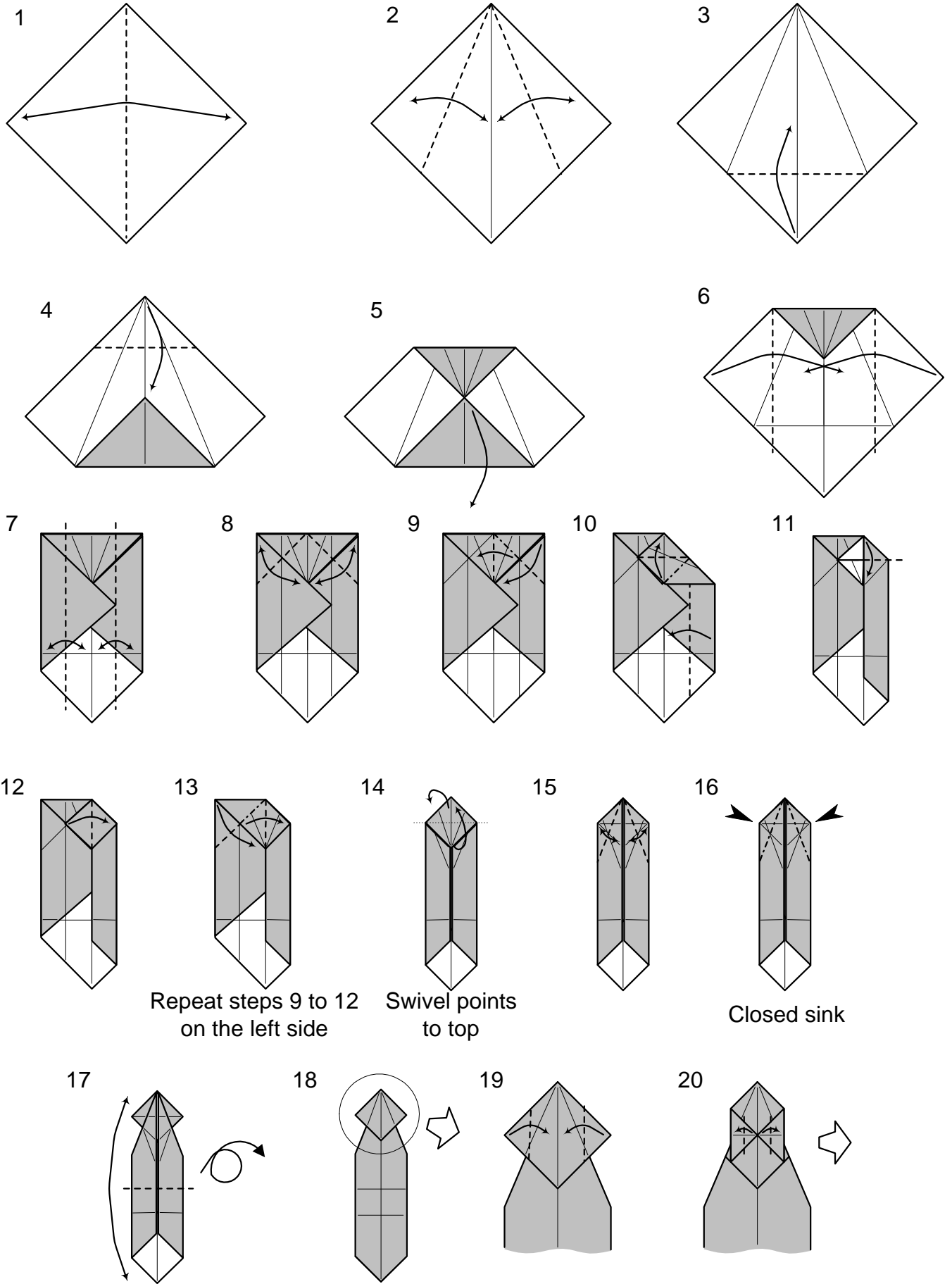

# Gigi the cat

21

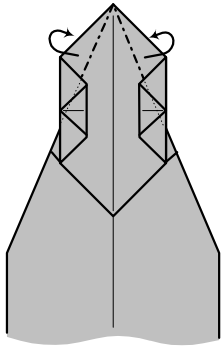

Fold 1 layer behind

22

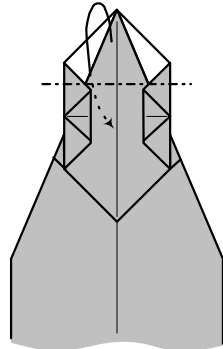

Fold point down  
inside model

23

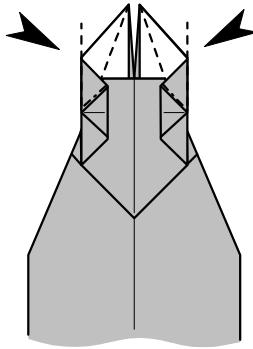

24

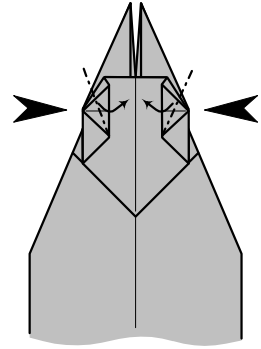

Squash folds

25

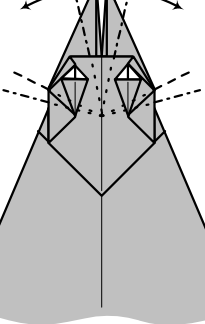

Swivel the ears  
(keeping double layer  
at the front)

26

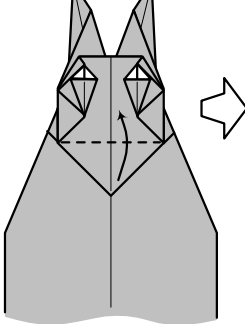

27

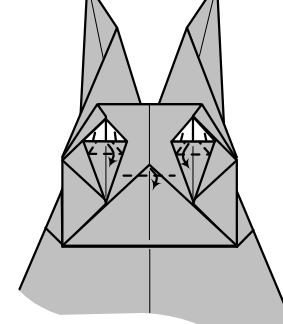

Fold tip of nose.  
Make 'soft' petal folds  
to form eyes.

28

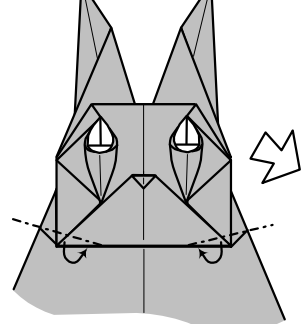

29

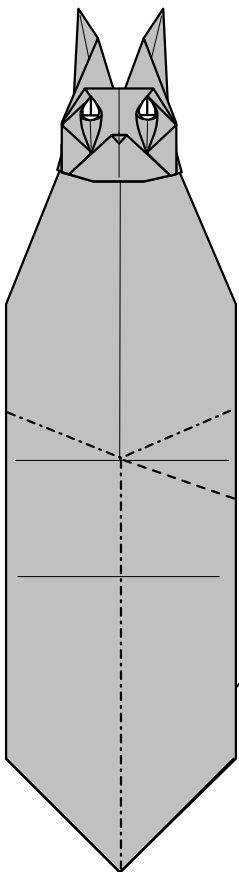

Rabbit ear

30

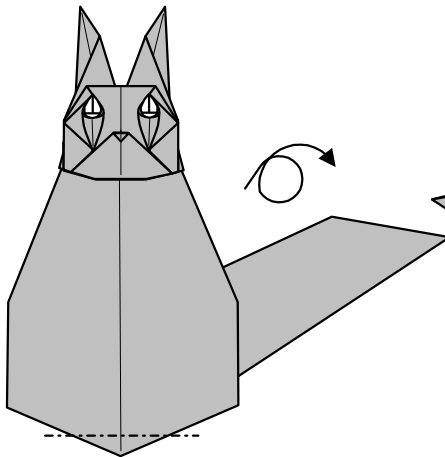

32

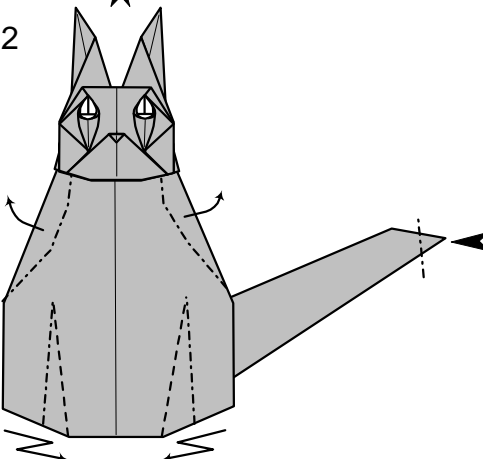

31

