

Ket_Sara

Sketch Design

01-40

ฟลายาลิ่งฟิช

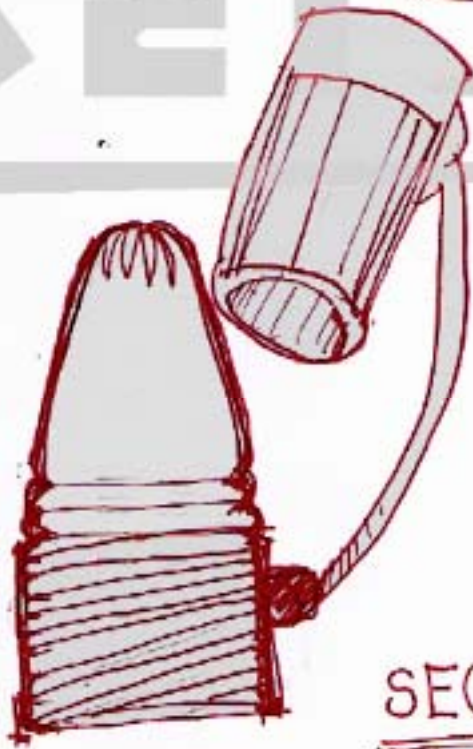
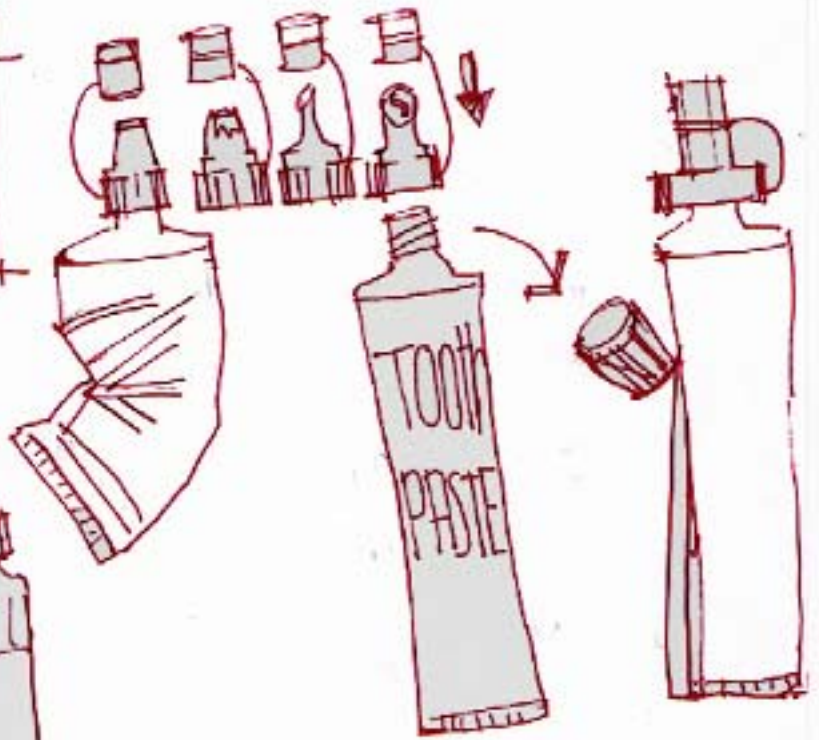

SECTION

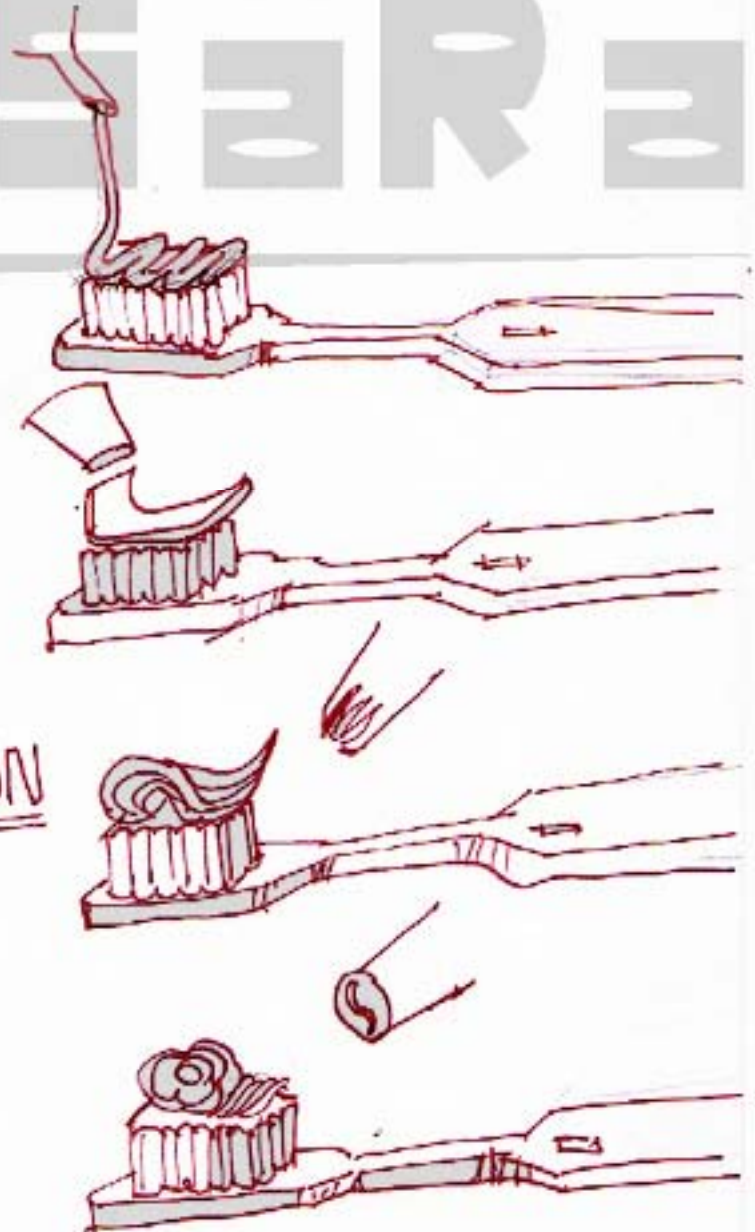
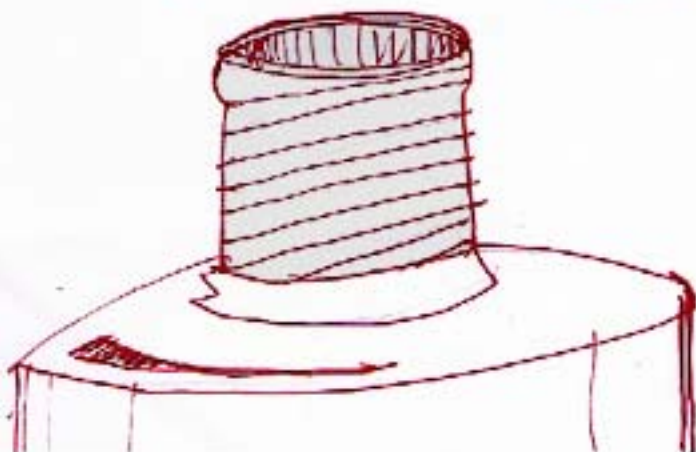

สำนักงาน

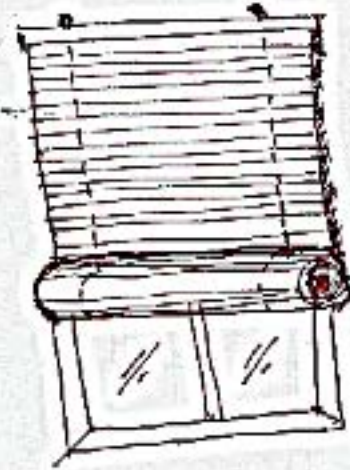

SSS

17/8/2555

ภาพการออกแบบหน้าต่างดัดแปลง

CONCEPT

19/8/2555

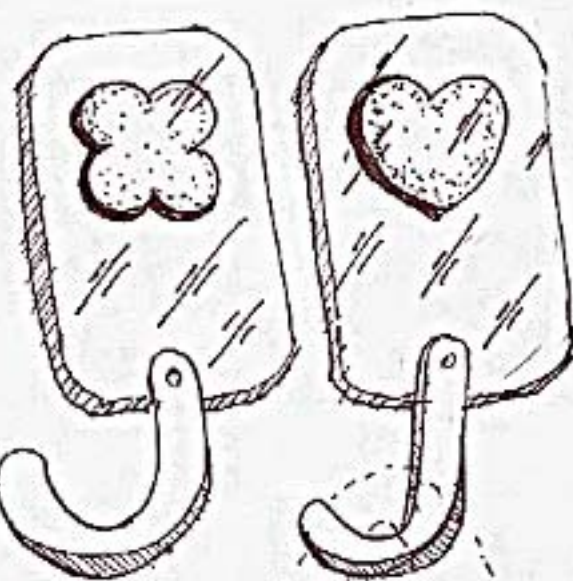
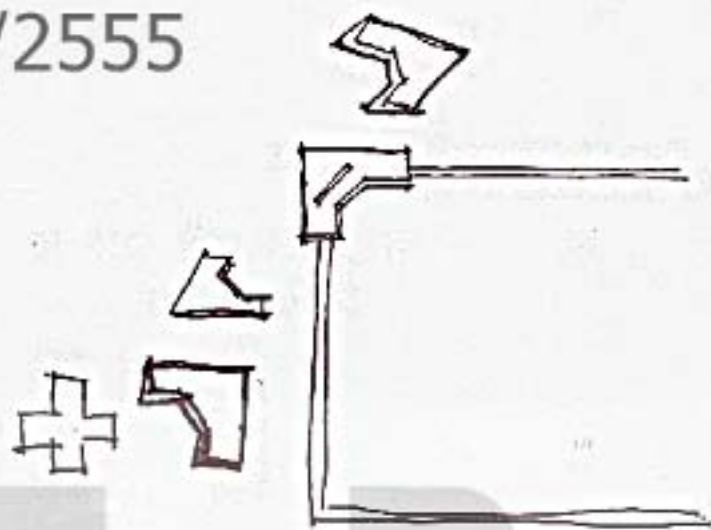
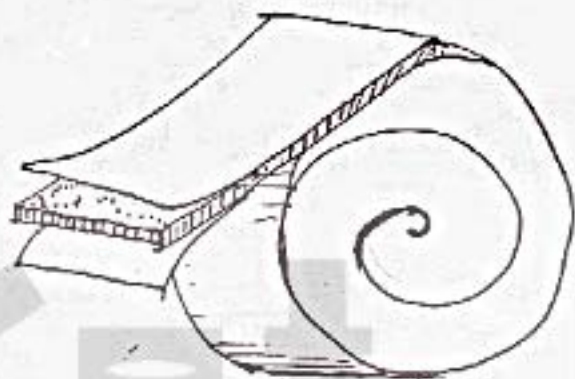

การเลี้ยงแมวโดย...

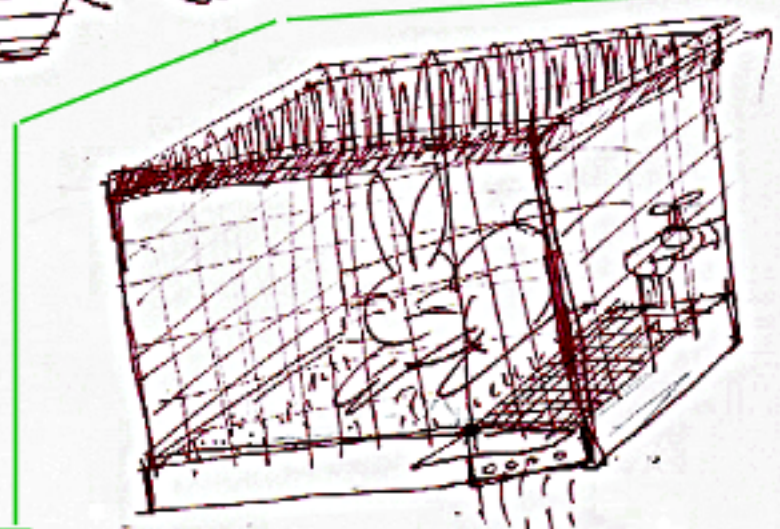

นาฬิกาข้อมือสวยๆ

21/8/2555

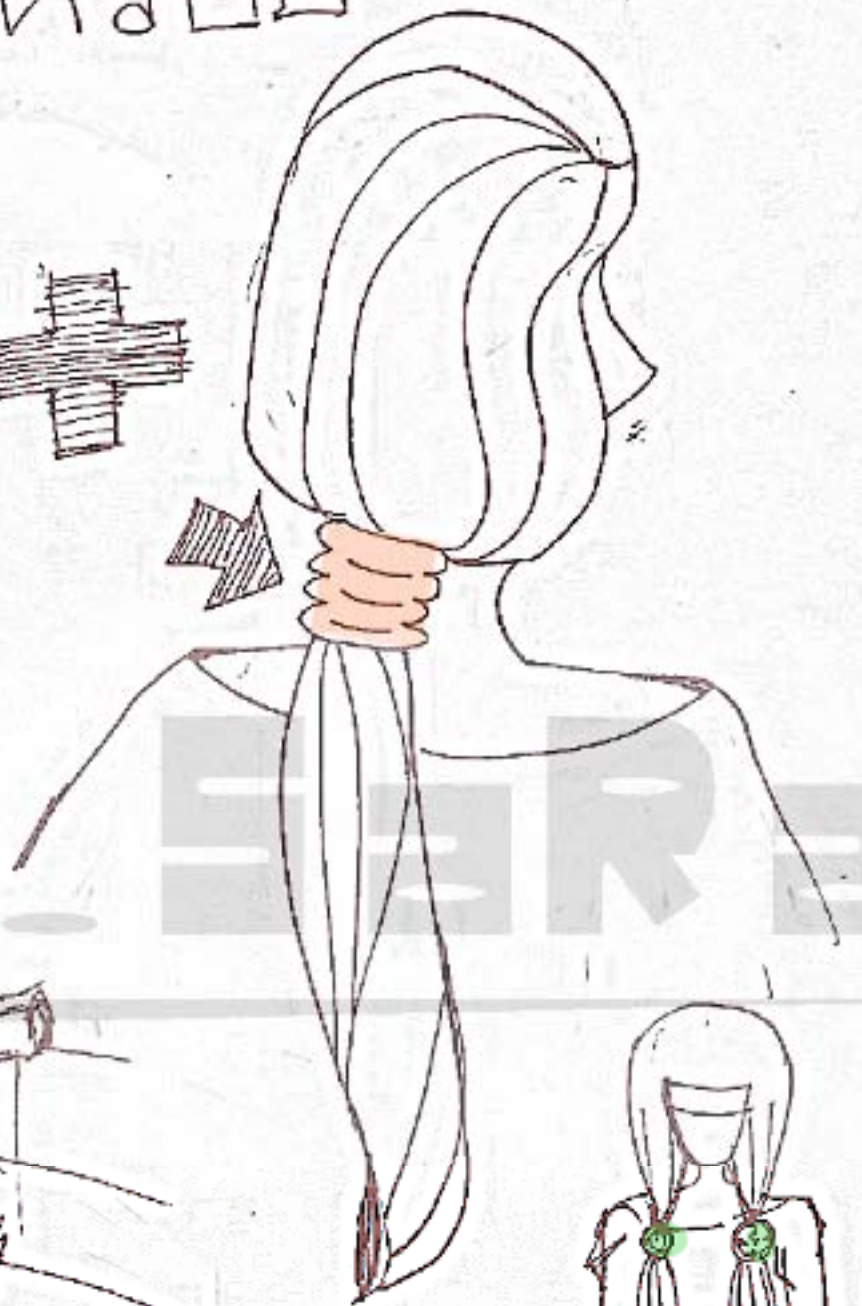
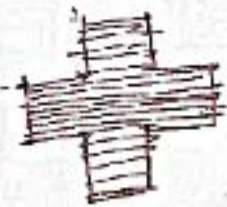
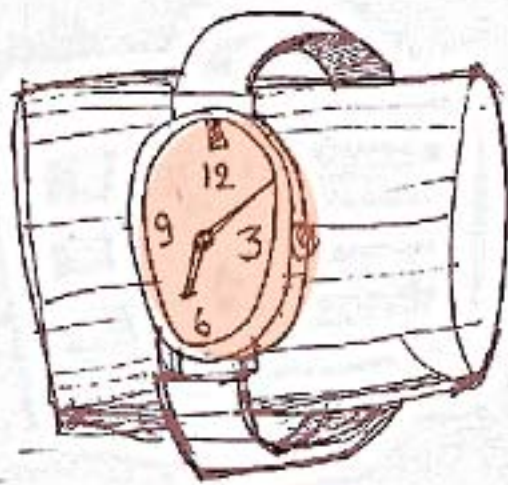

Kat-ERRE

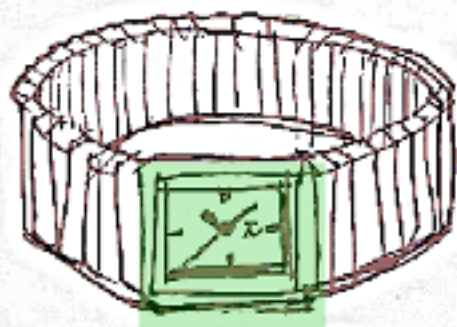
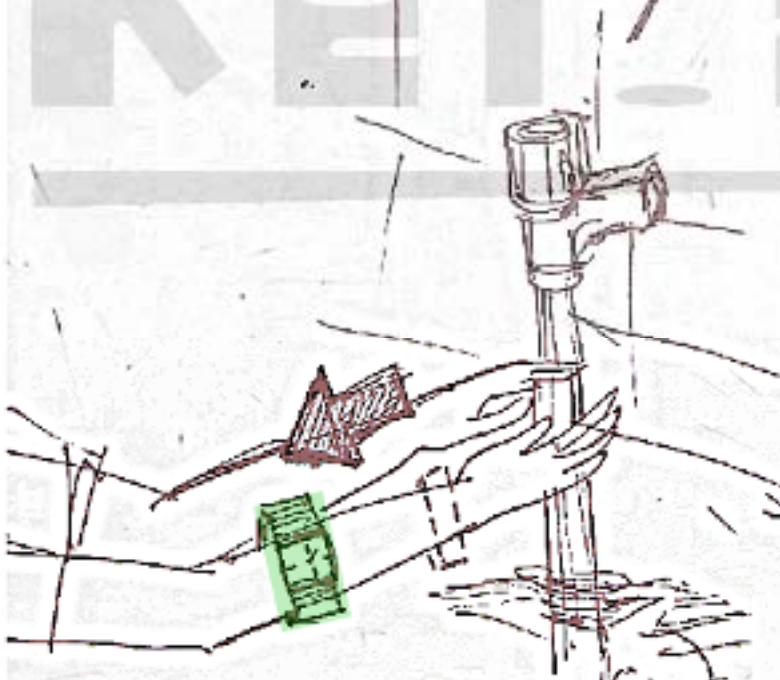

เทียนหลากสีและประติมากรรม

22/8/2555

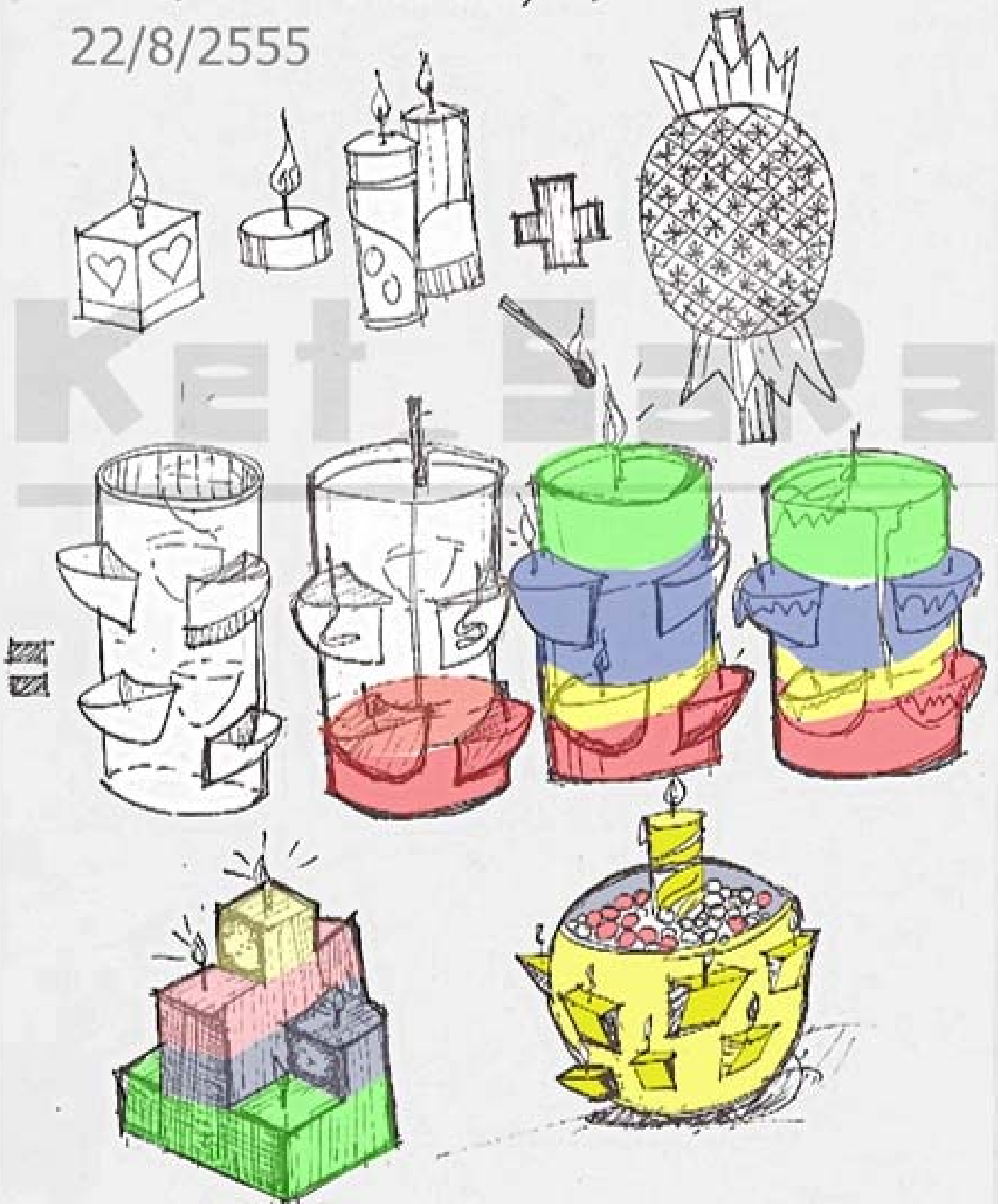

สถาปัตยกรรมศาสตร์

สถาปัตย์

๑

23/8/2555

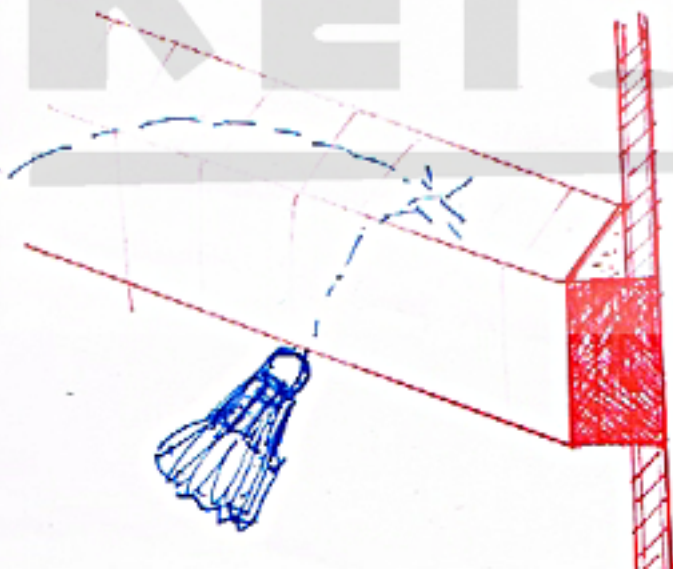
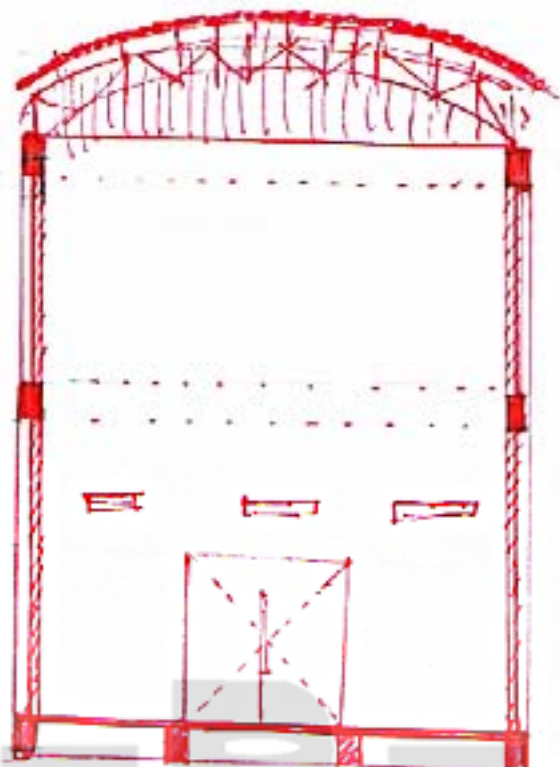
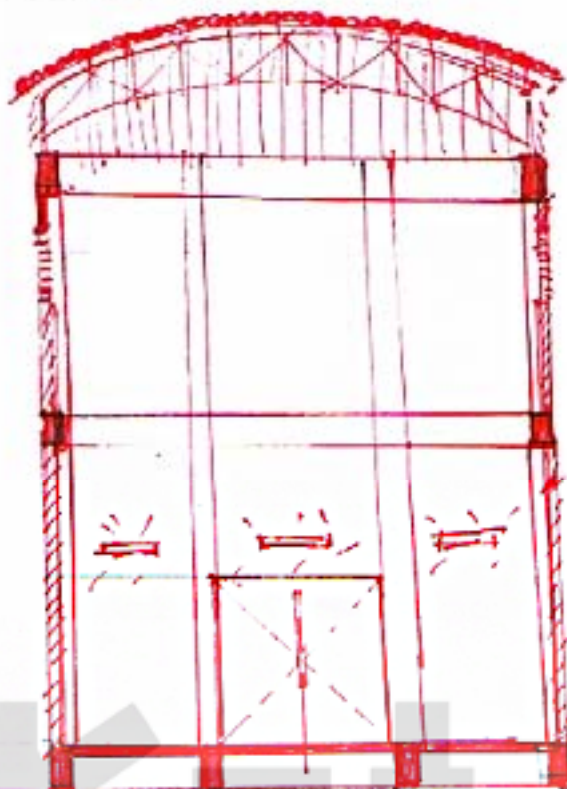
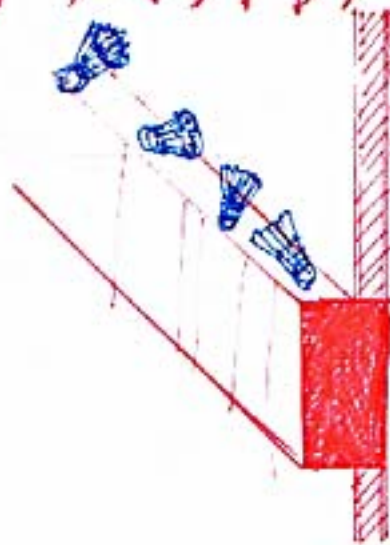

สมุดการเขียนลายเส้น

24/8/2555

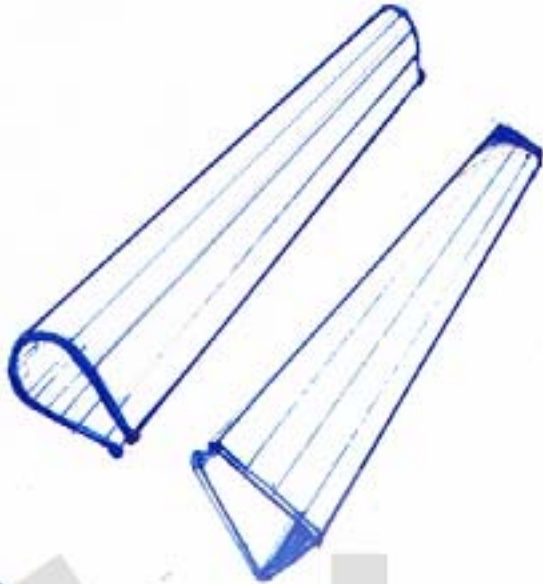

ตำแหน่งท่อในสายยาง



25/8/2555





บอลลมบนฟ้า

26/8/2555

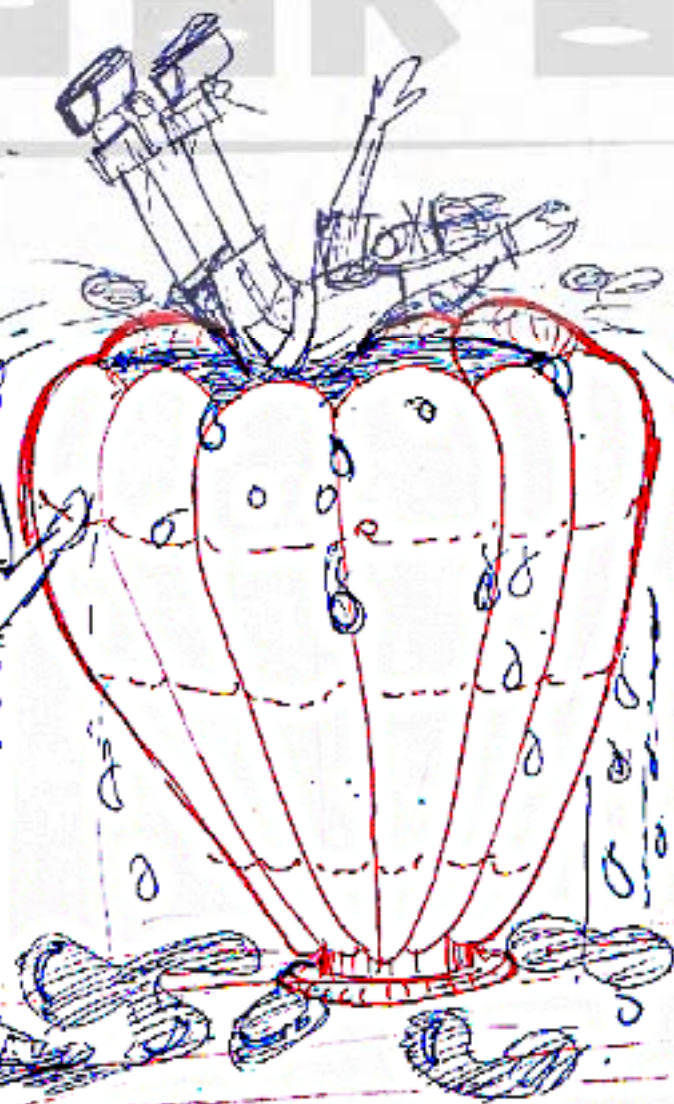
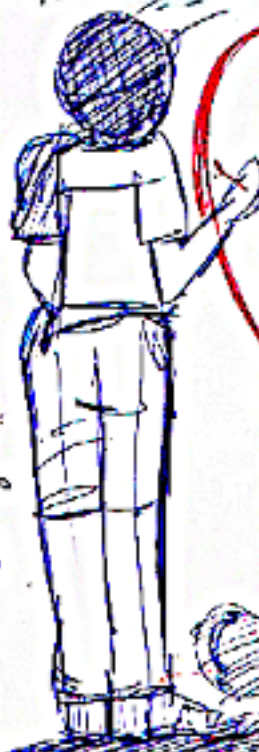
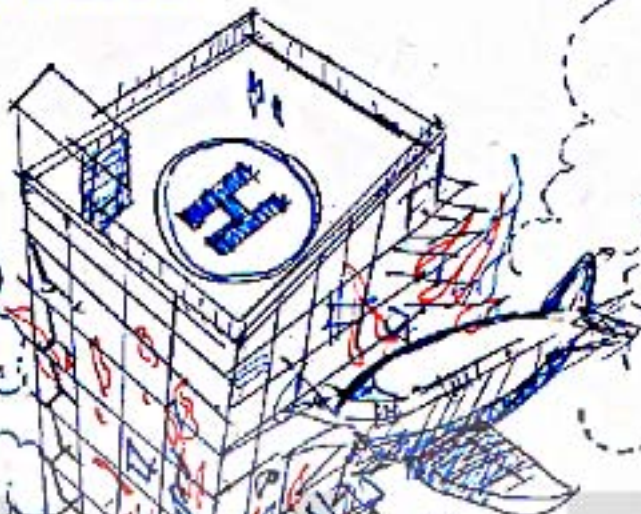

27/8/2555

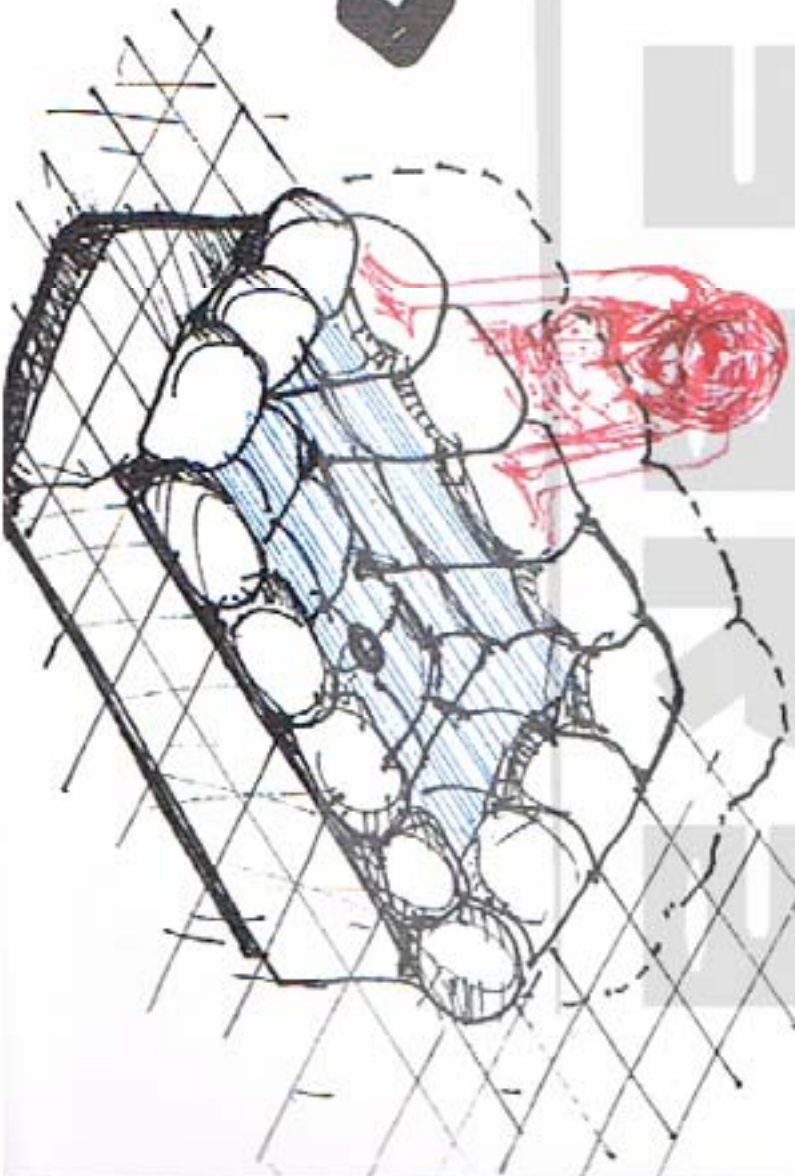
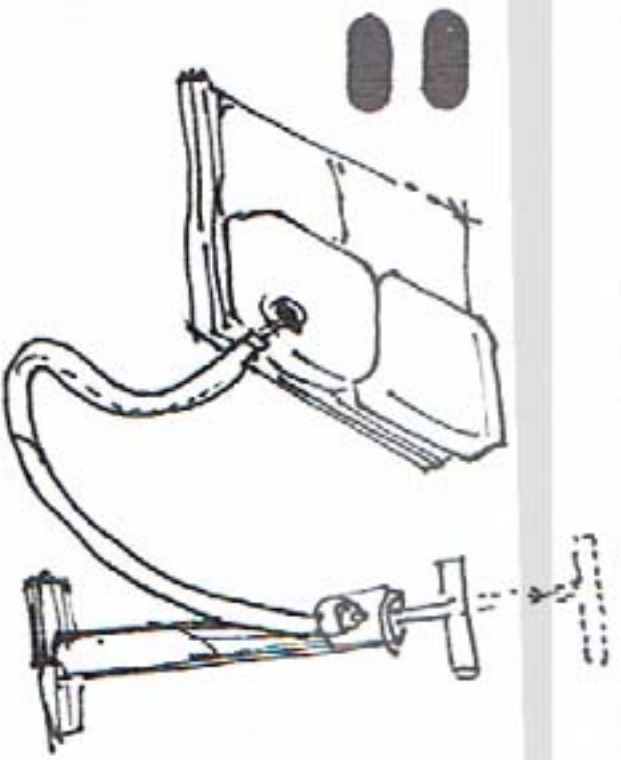
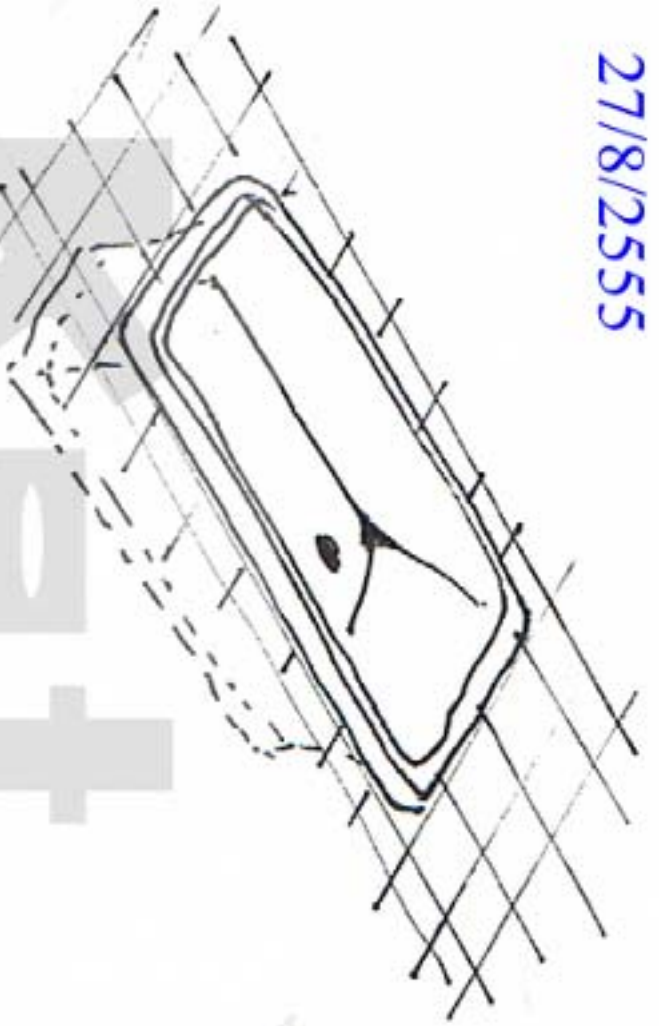

เครื่องซักผ้า, รองเท้า, ชุดชั้นใน

28/8/2555

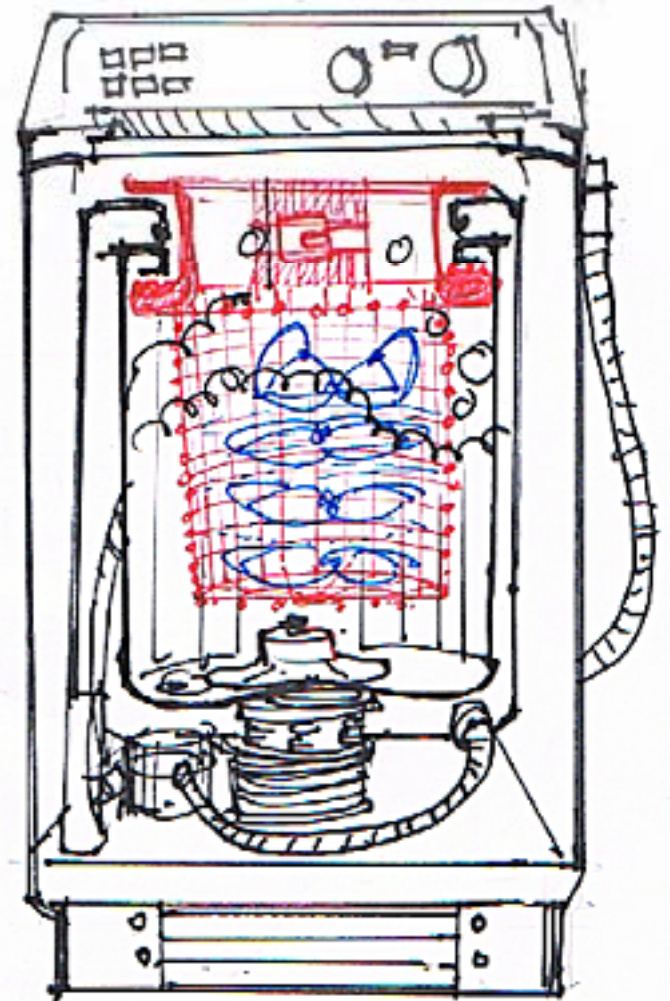
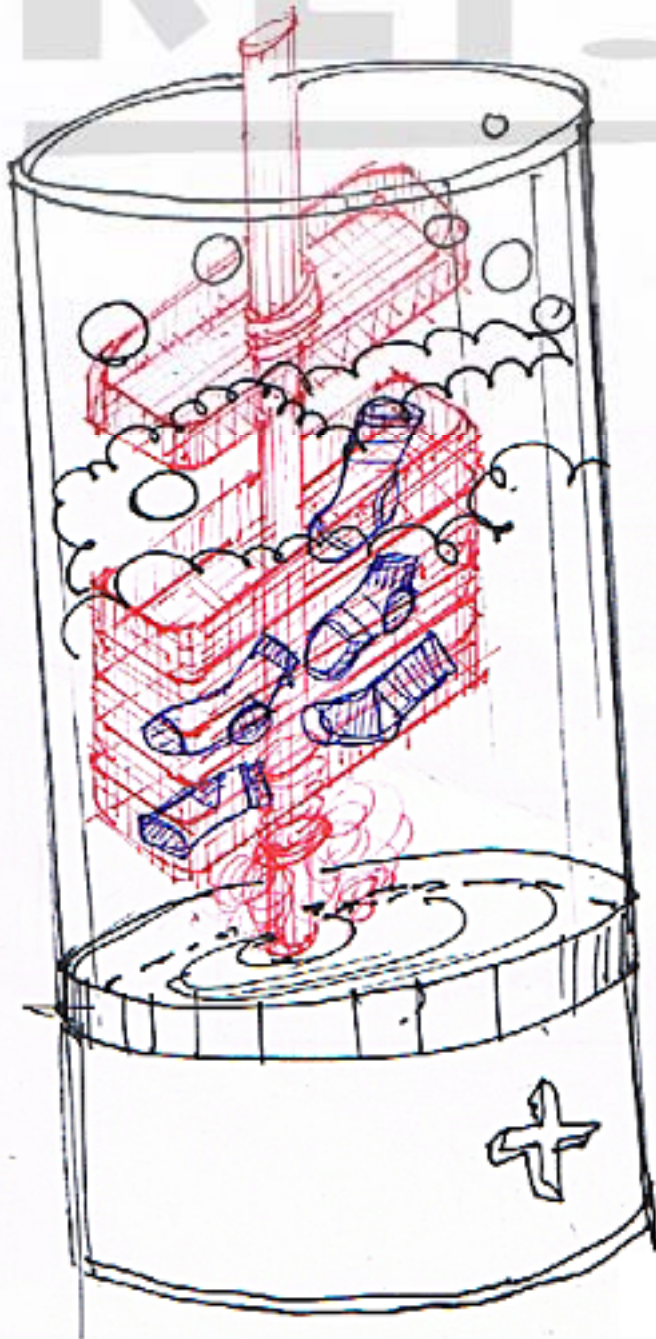

กรรไกรตัดกิ่งใต้น้ำ

29/8/2555

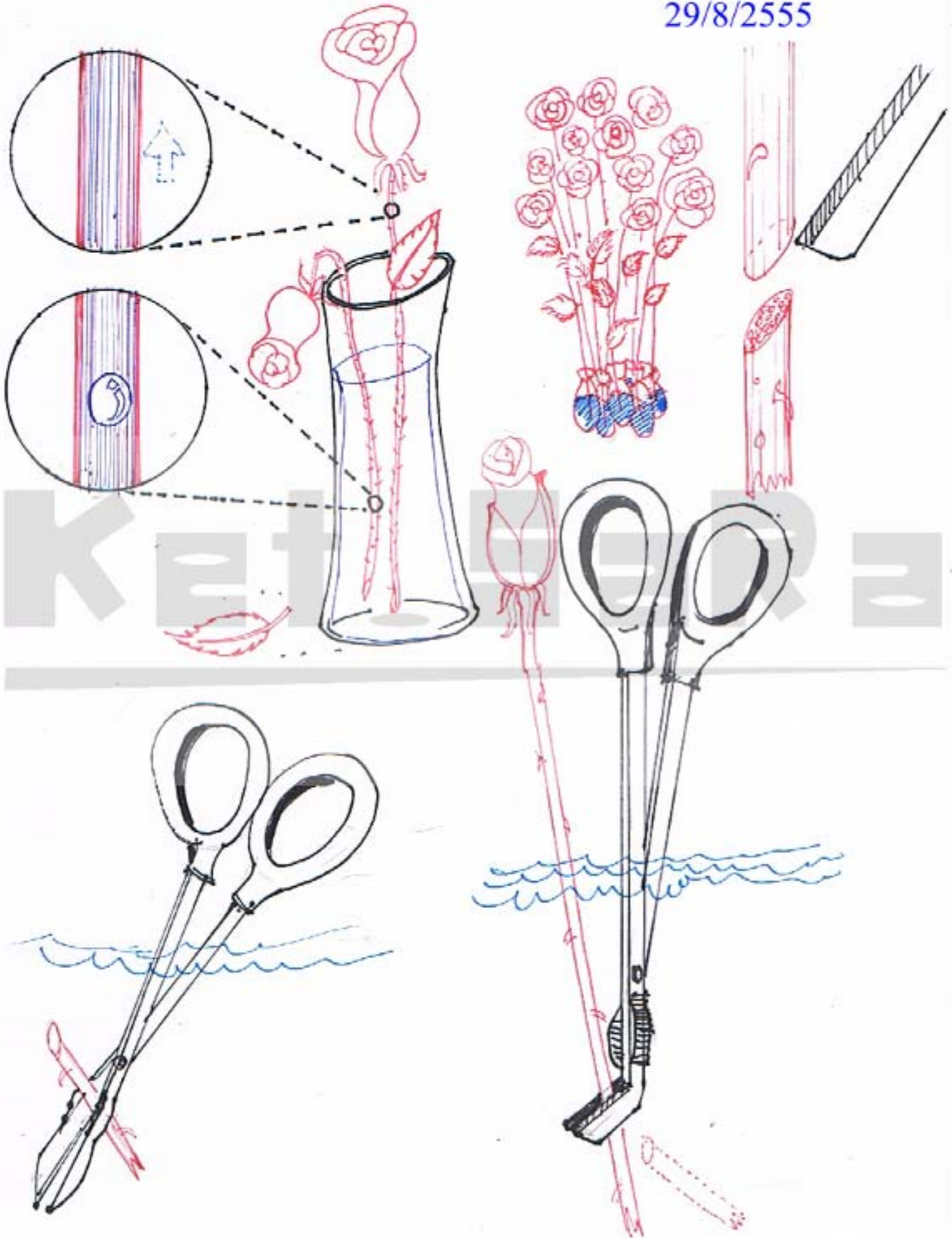

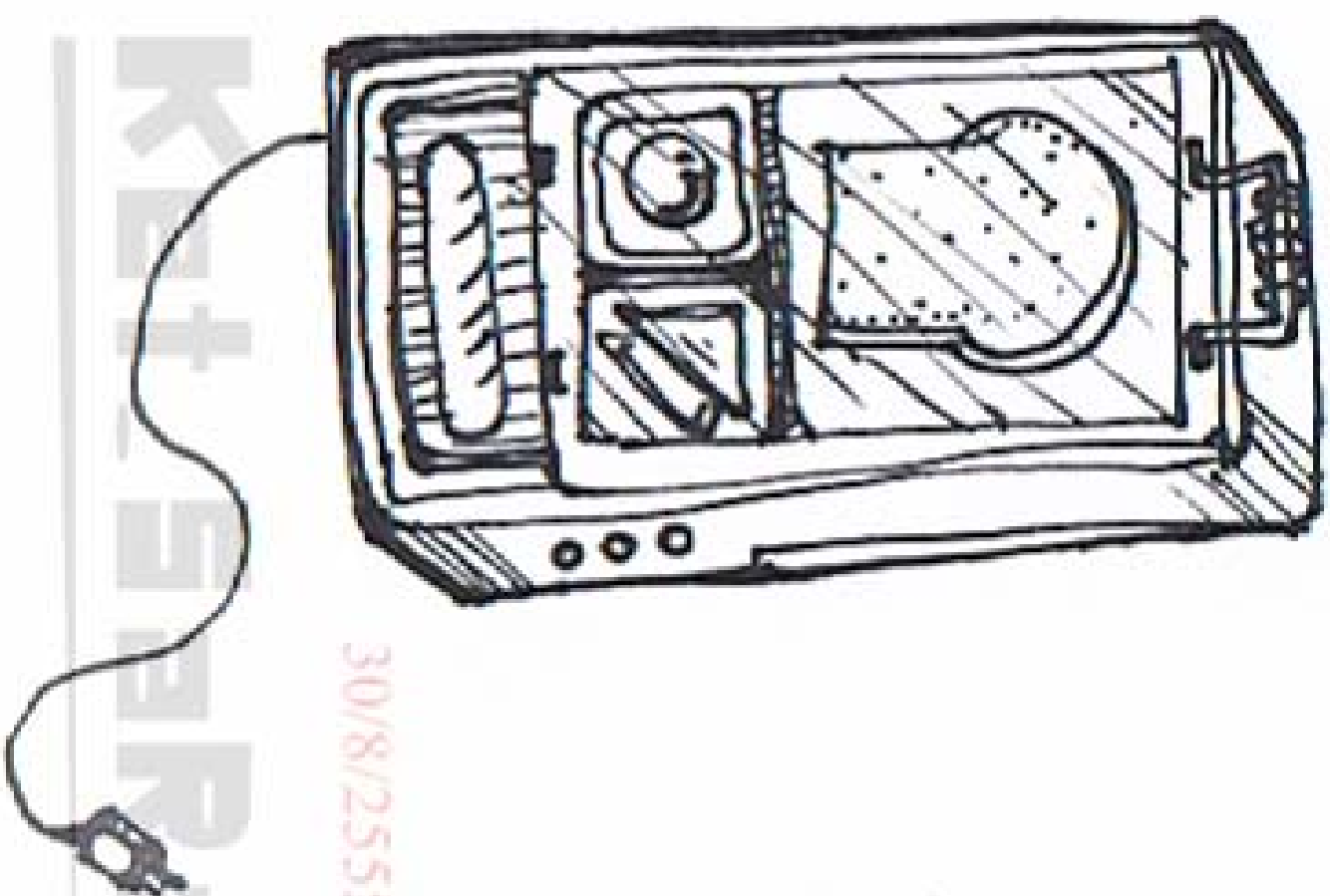
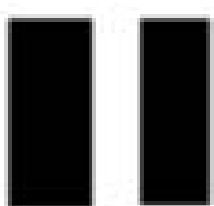
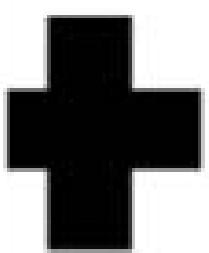

30/8/2555

h*nsa

ถุงเท้าหนังร้าน

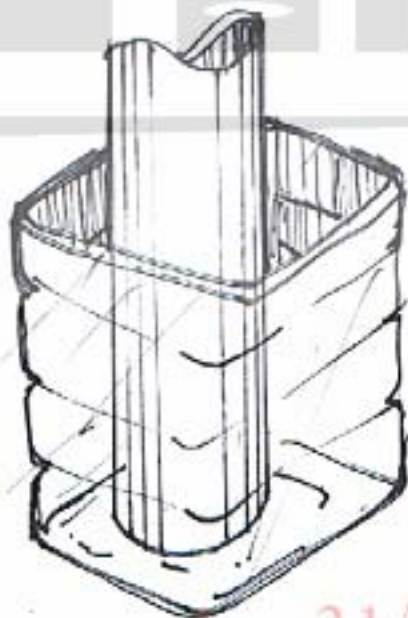
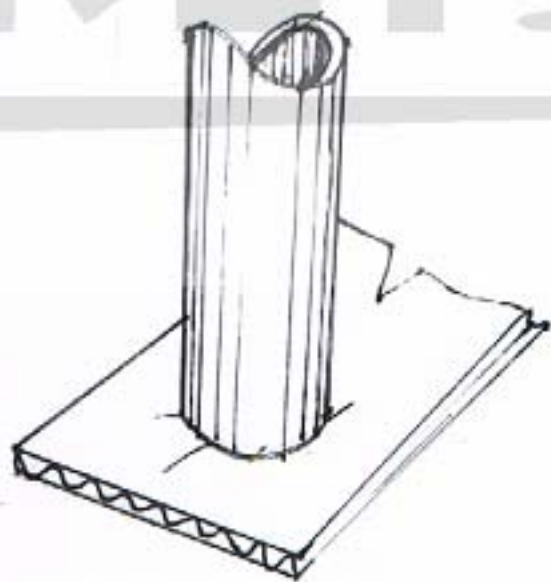
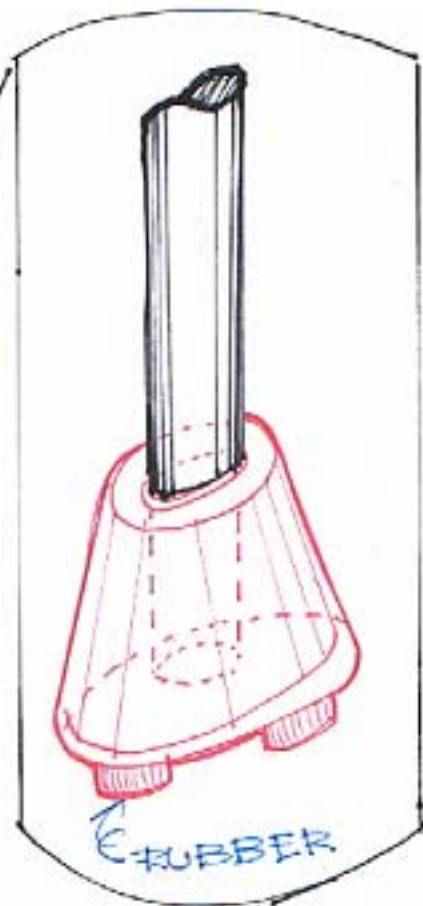
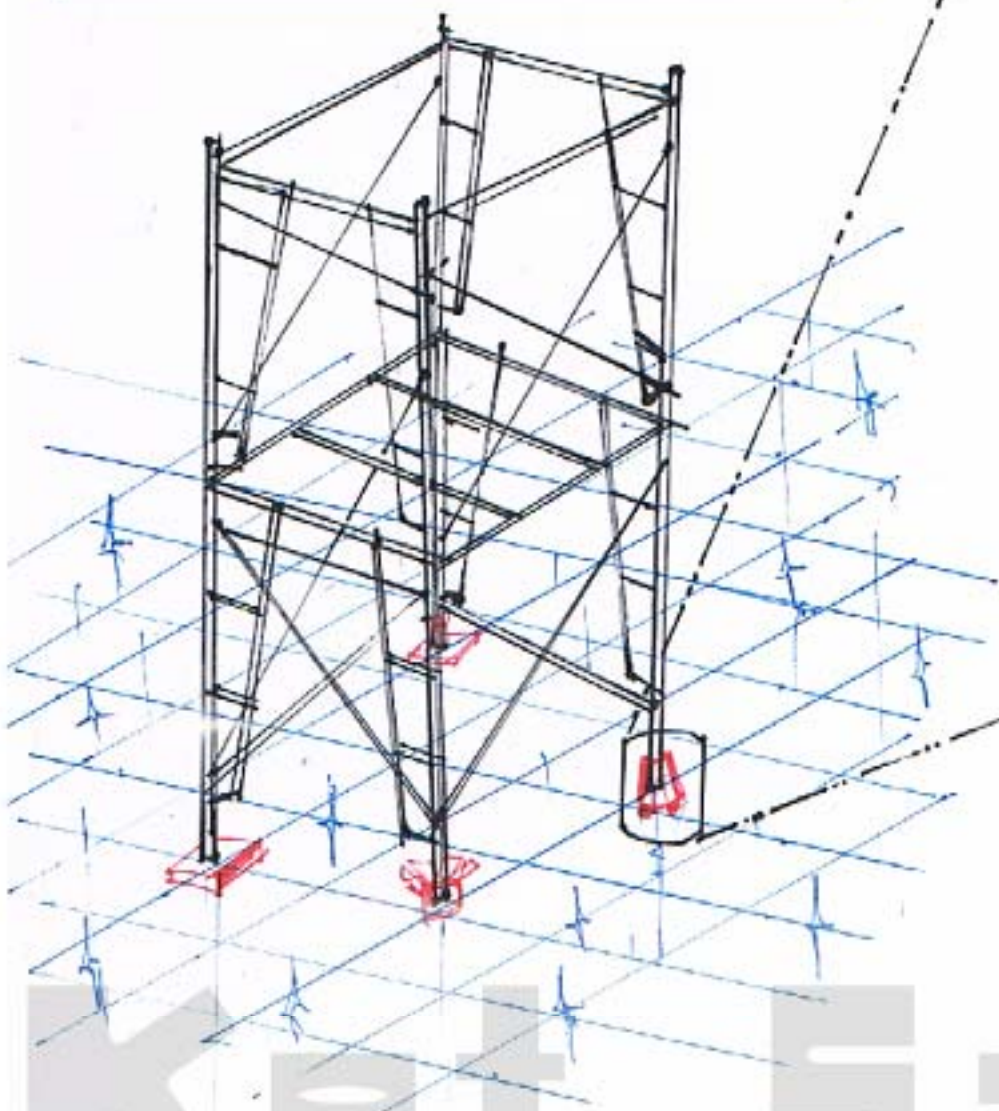

31/8/2555

สระว่ายน้ำออกกำลังกลางแจ้งเดี่ยว

1/9/2555

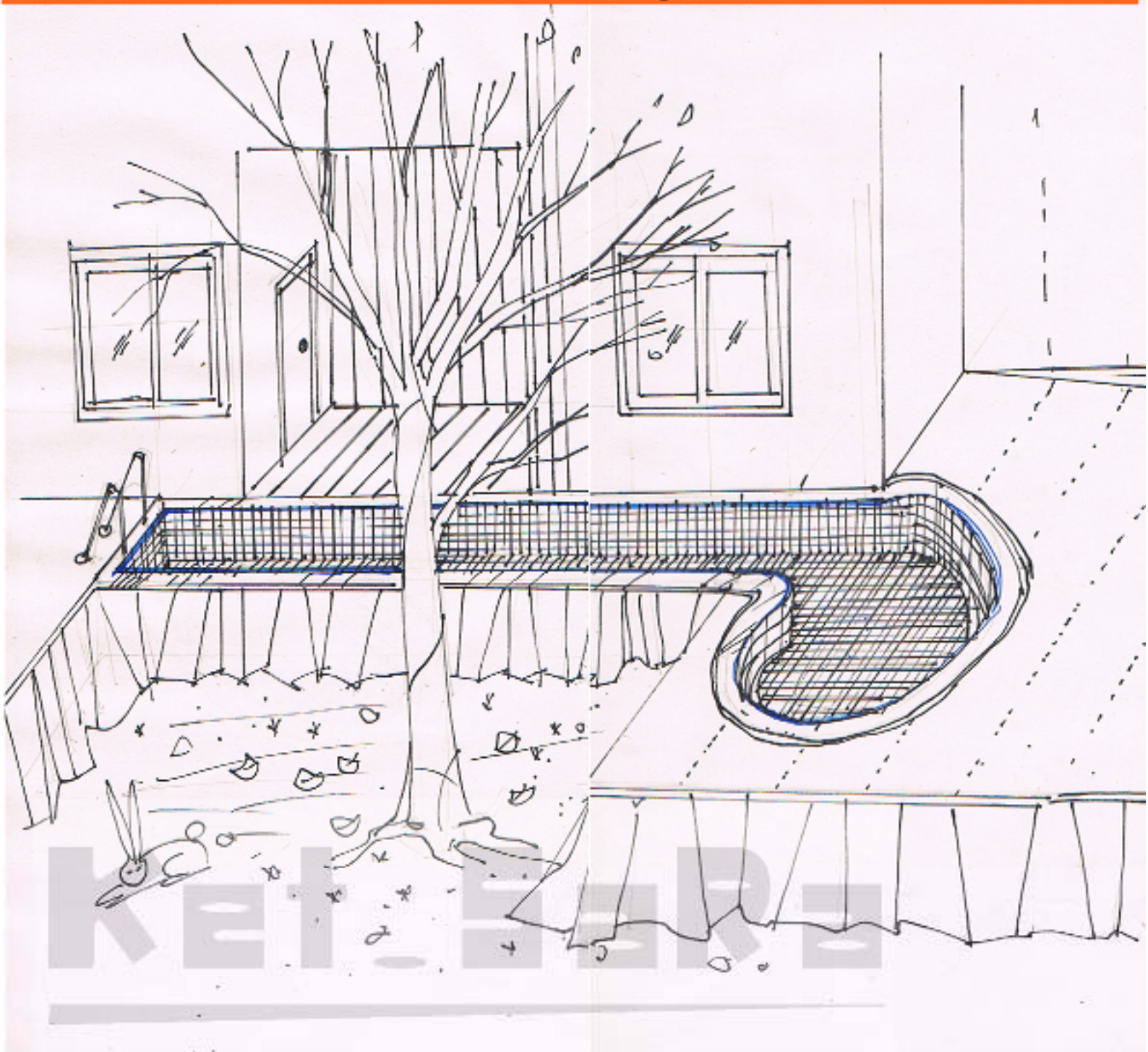

ผ้าดีลองกิระดม

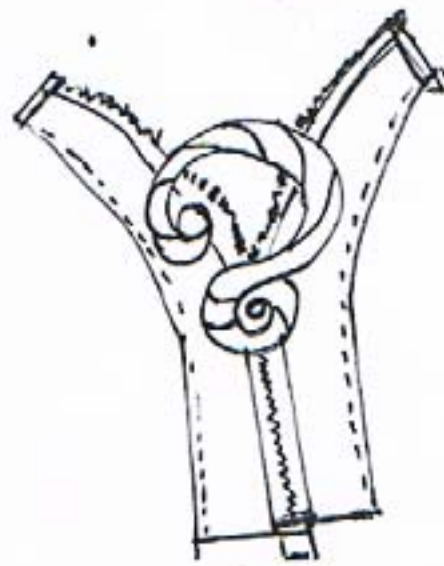

CONCEPT

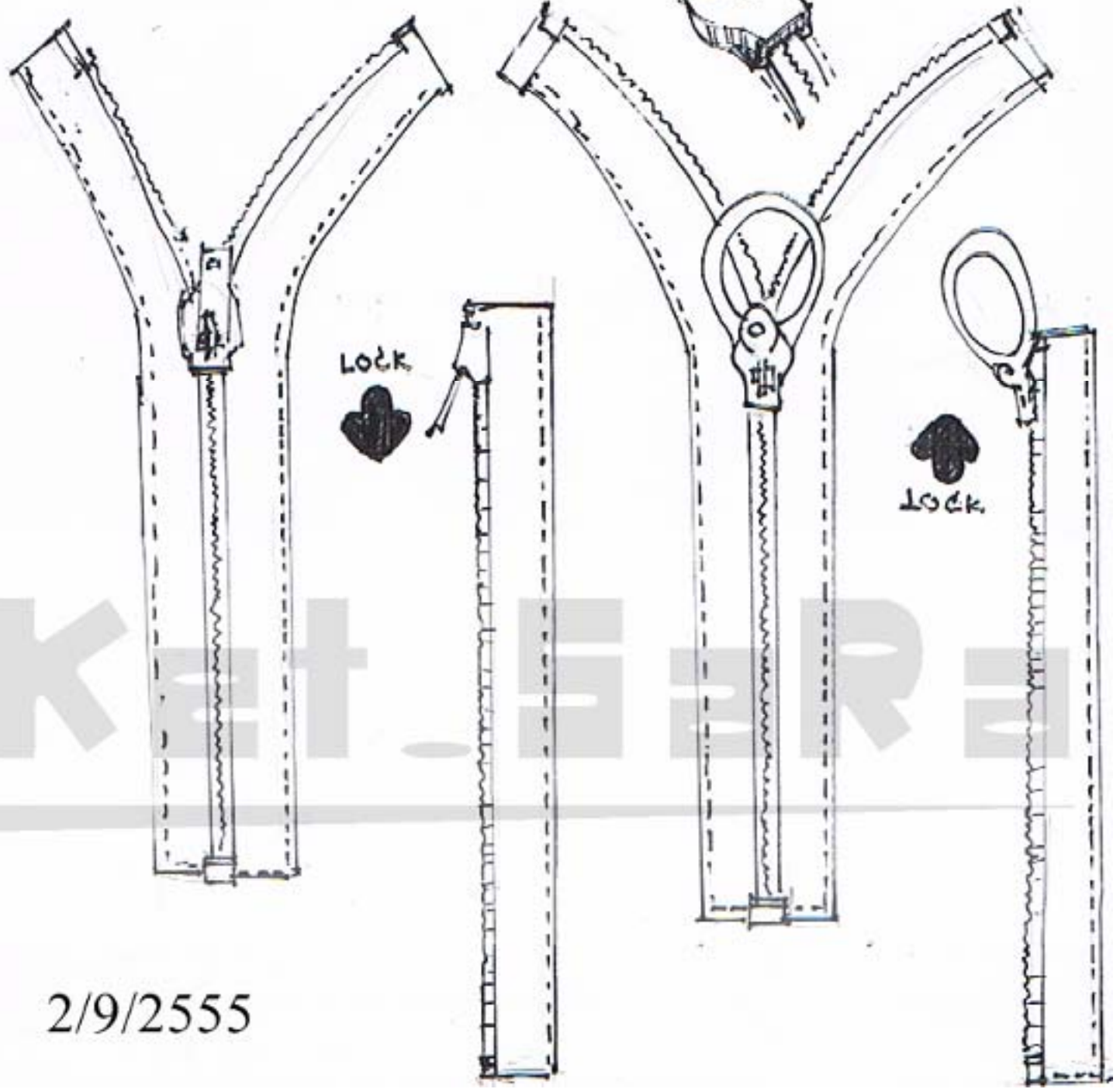
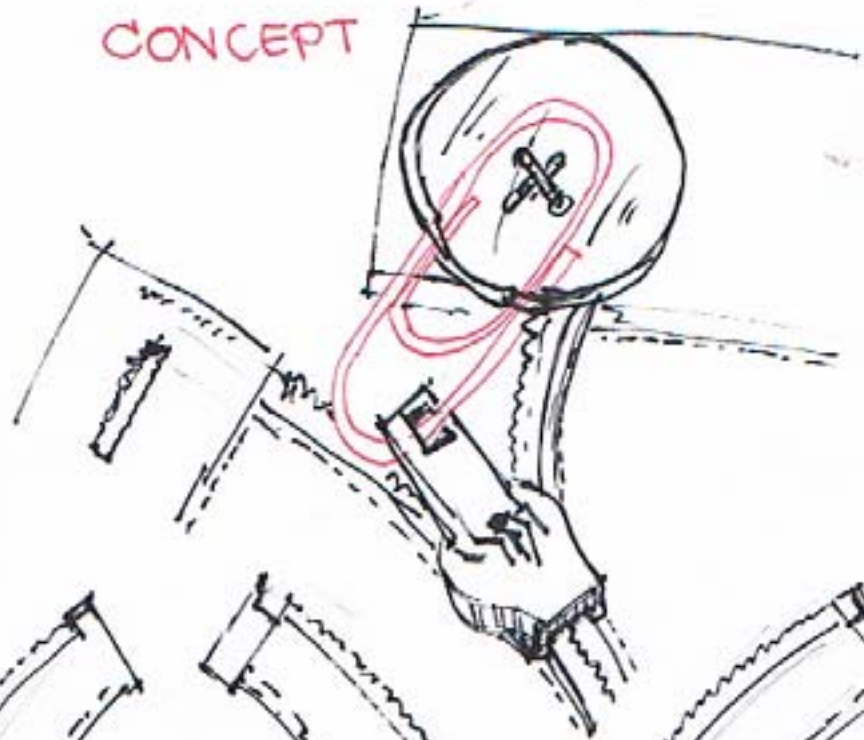

2/9/2555



Go raemon

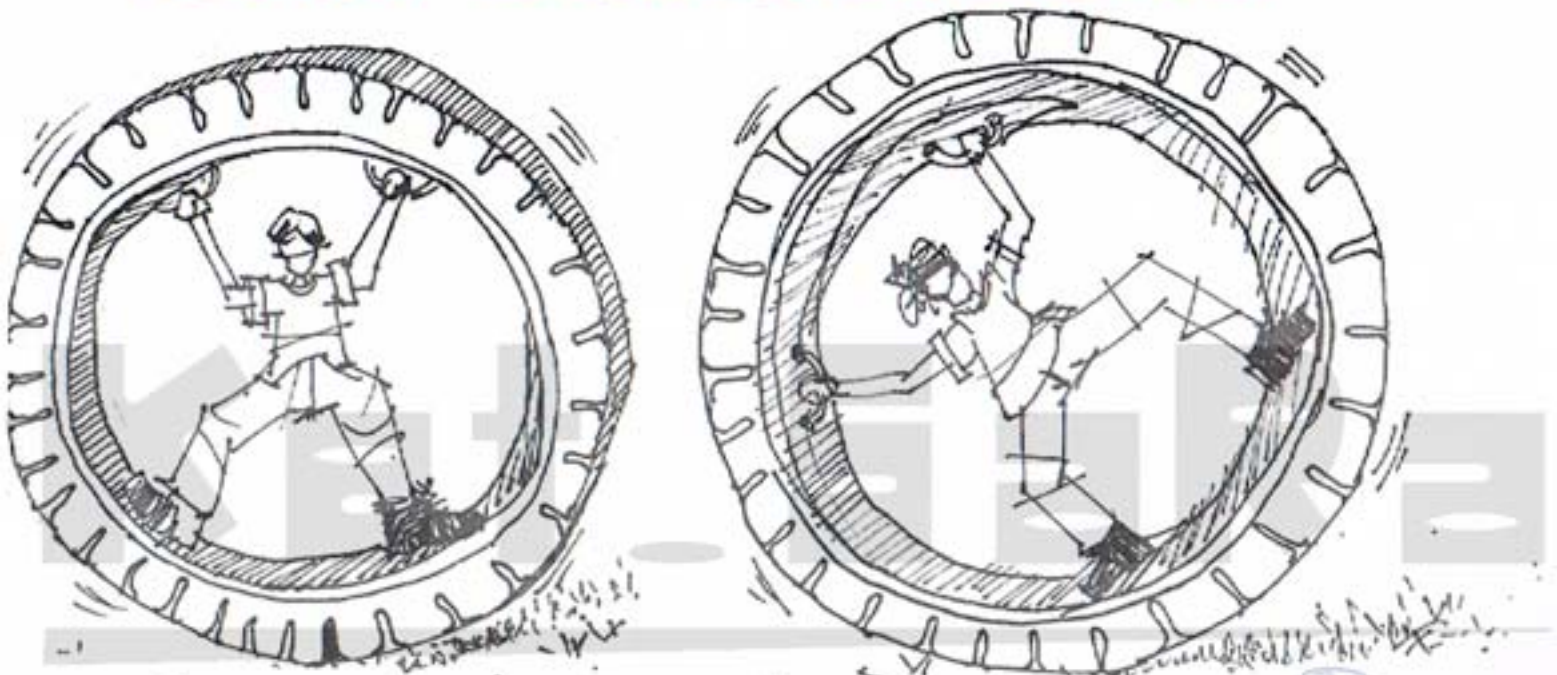

3/9/2555

กระปุกออมสินแยกเหรียญ

4 / 9 / 2 5 5 5

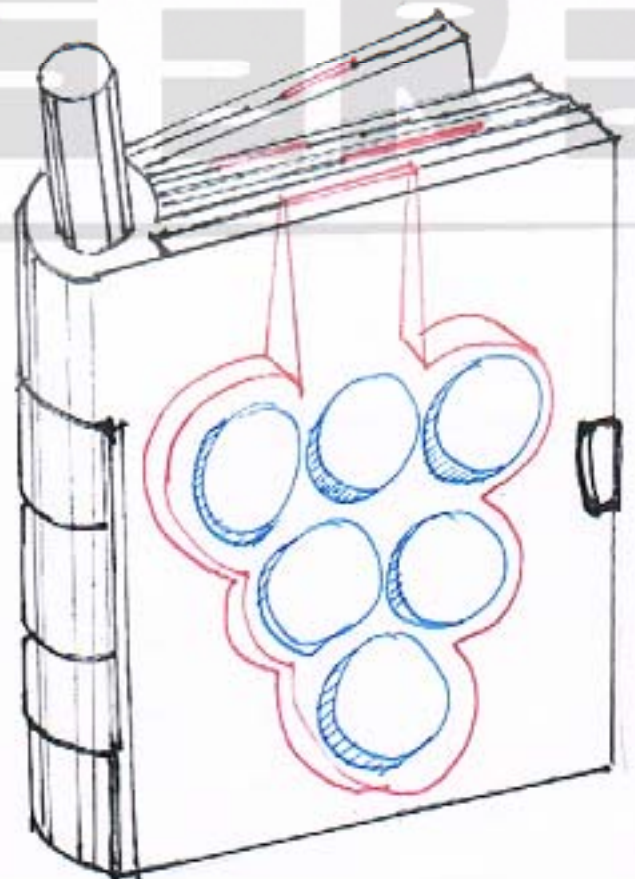
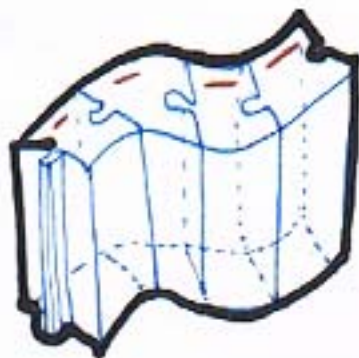
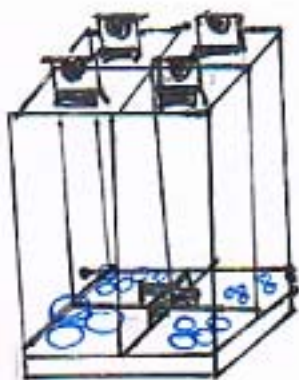
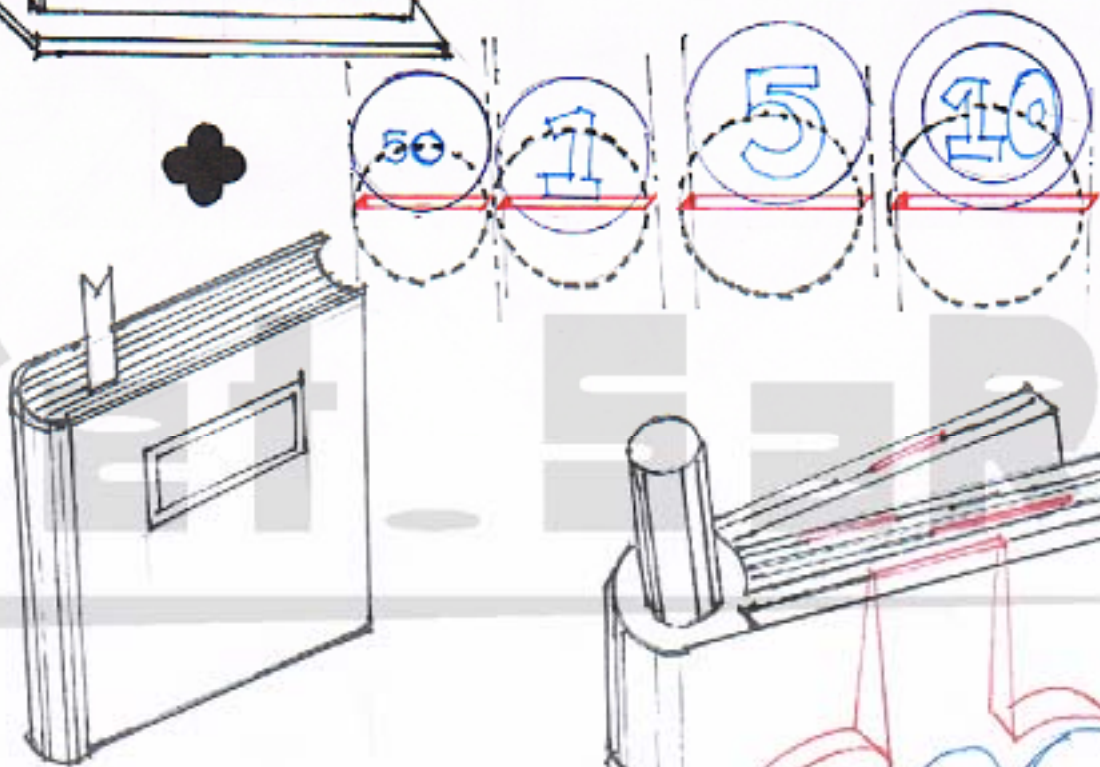
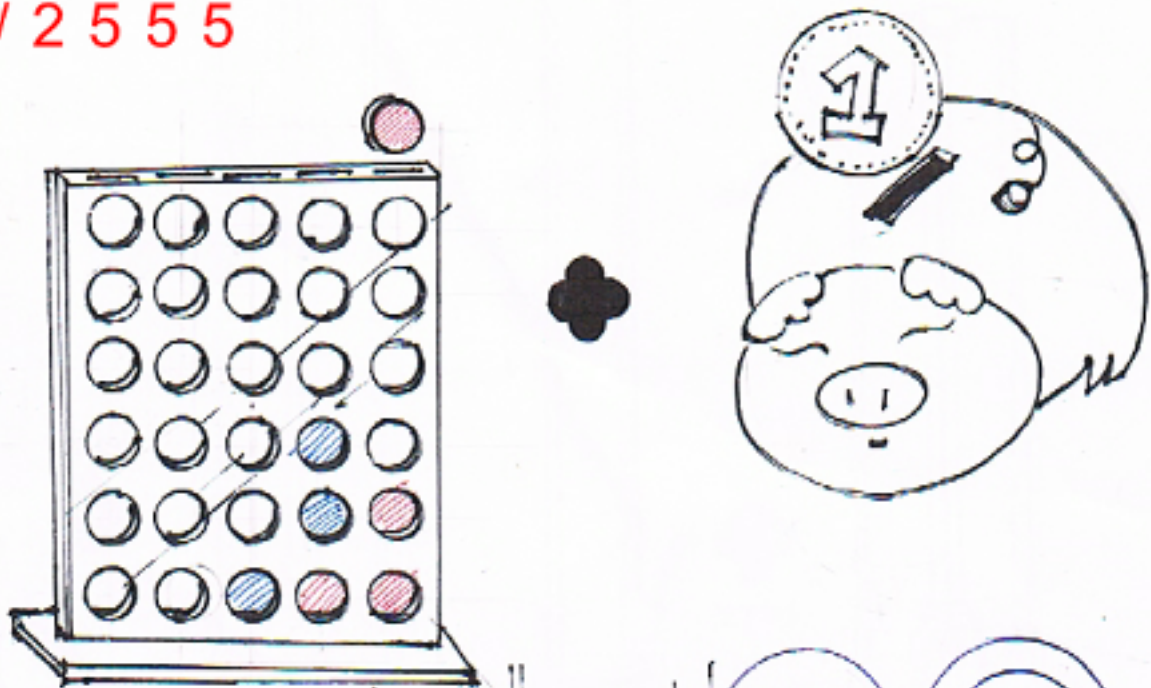

Science of Water

5/9/2555

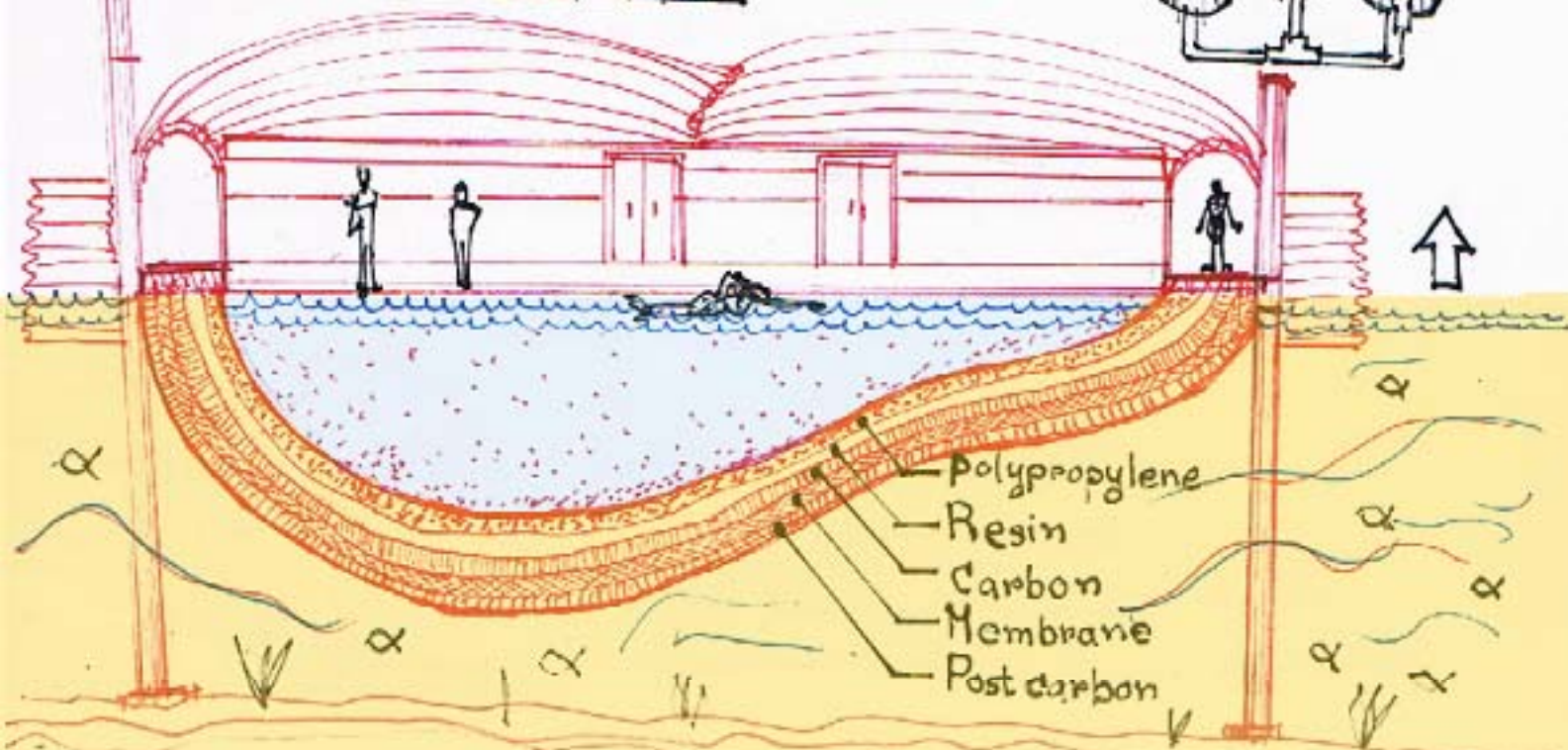
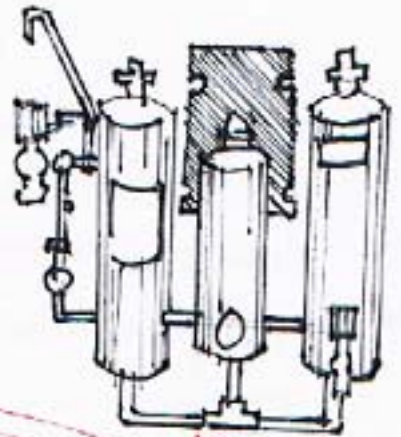
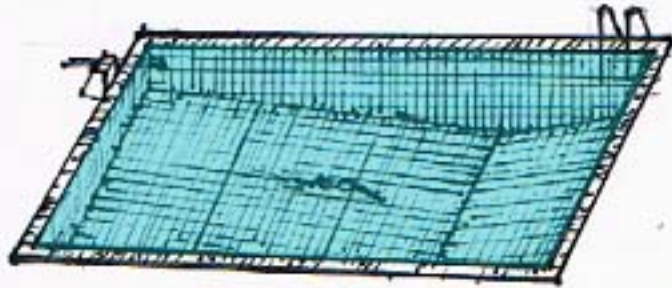

Ket-SARA

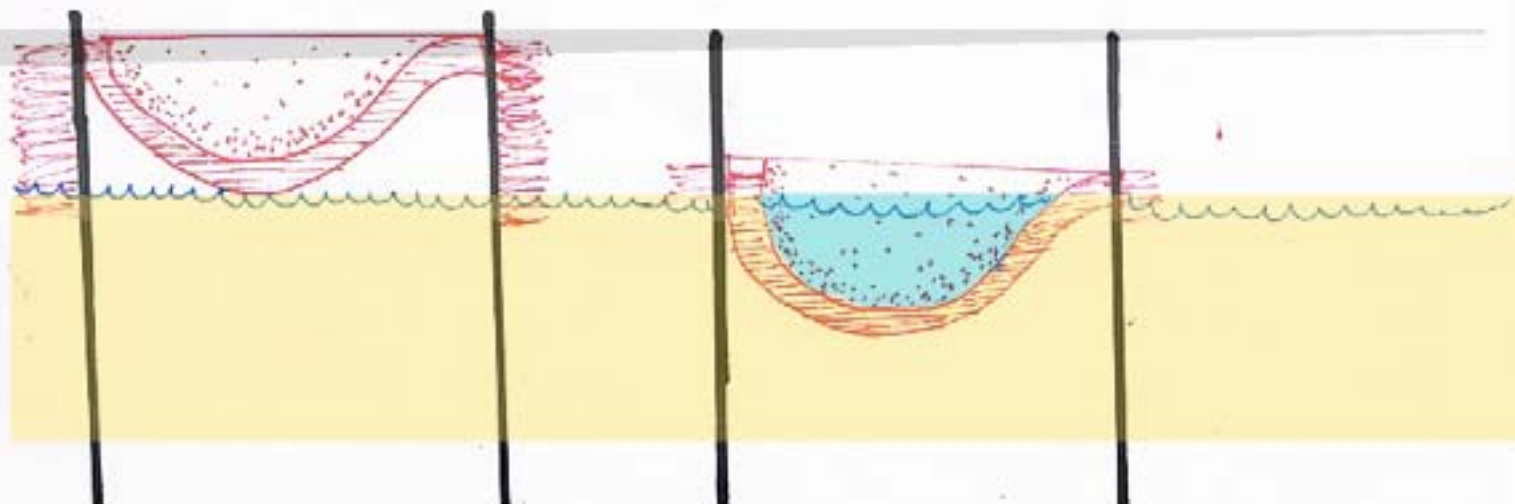

ที่นั่งข้างคนขับ

5/9/2555

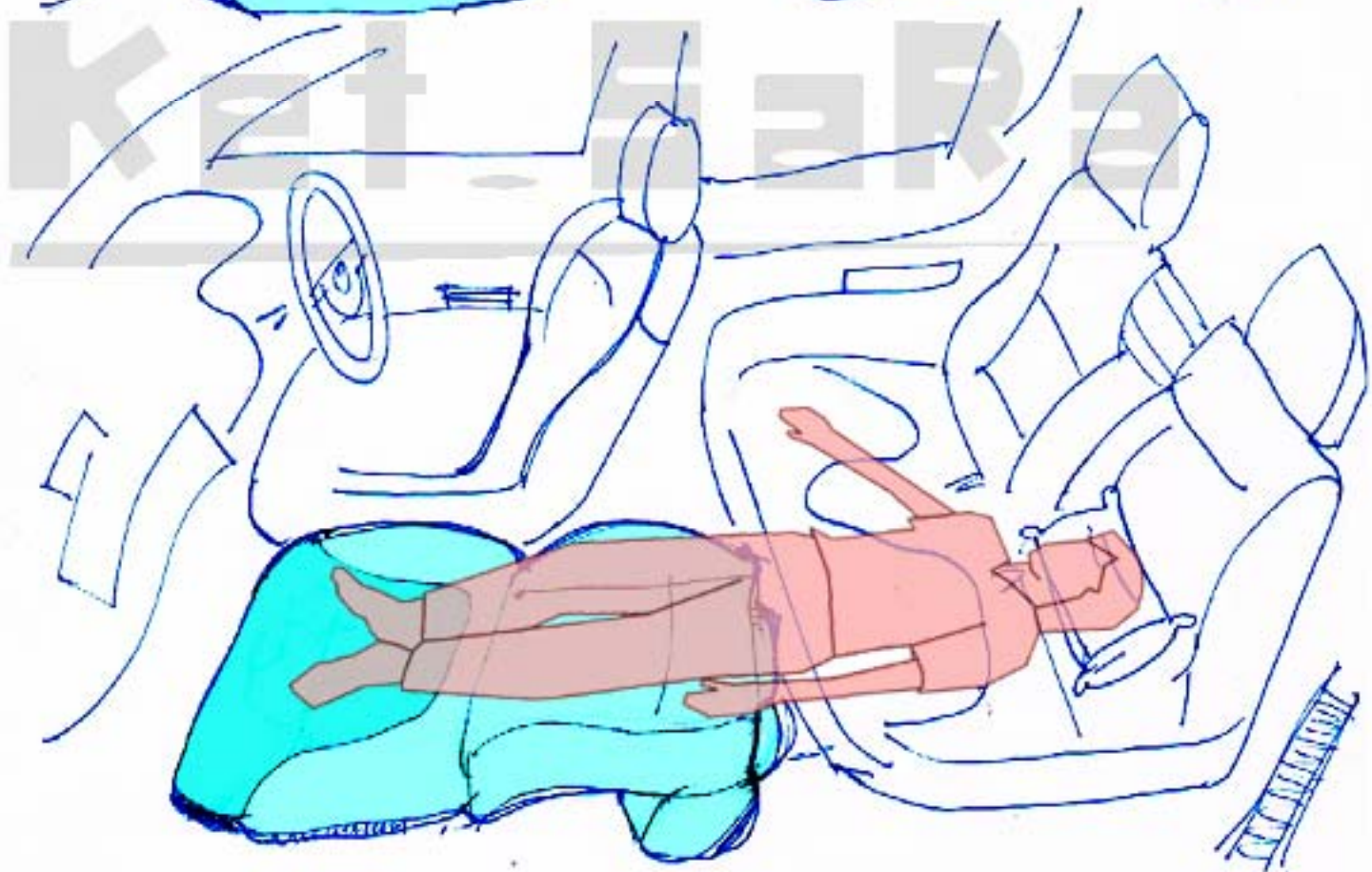
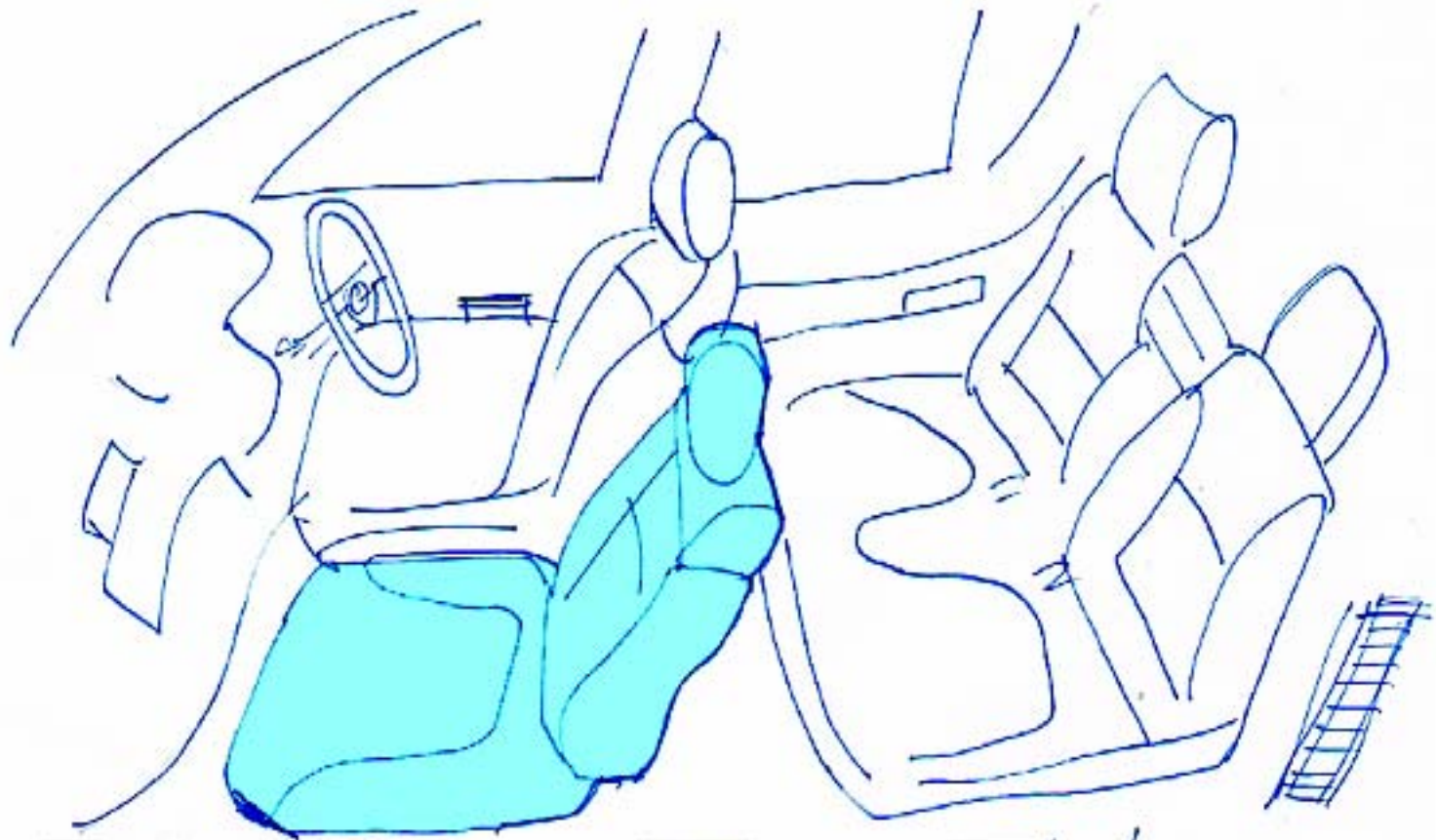

coach bus



T.V.

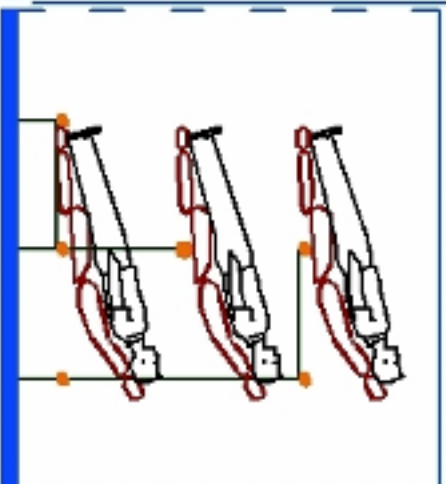
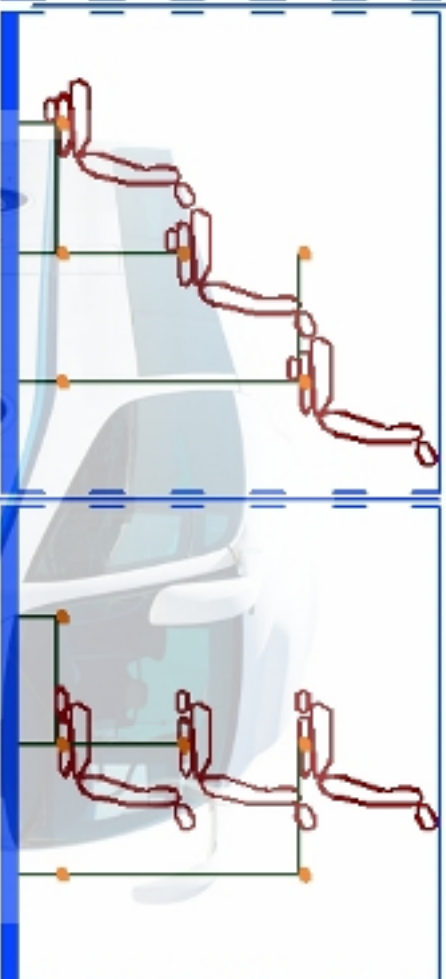
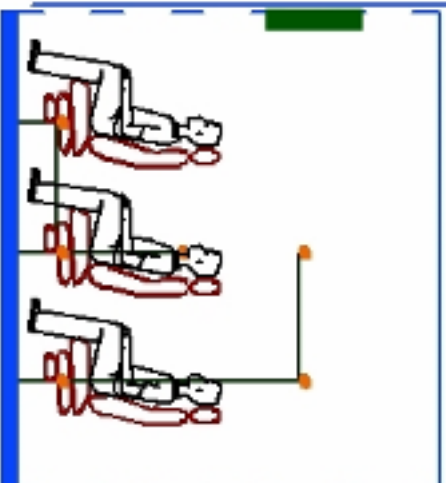

Ket-SARA
6/9/2555

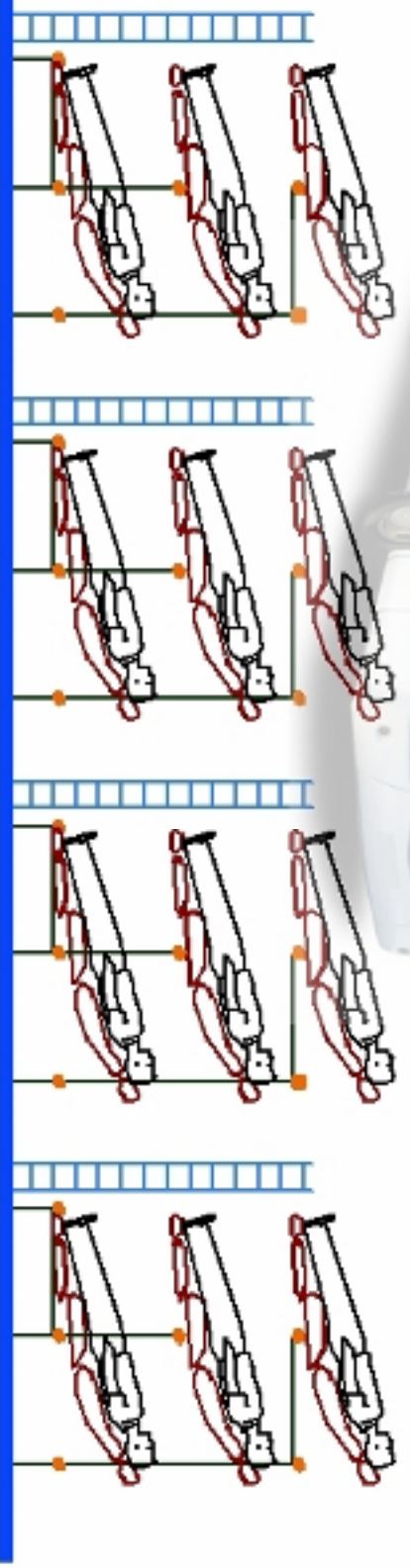

T.V.

coach bus



2nd

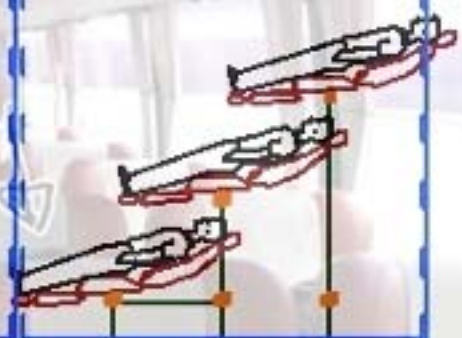
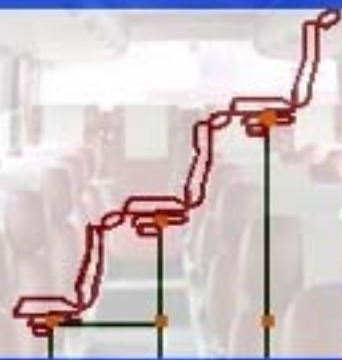

1st



Ket. SaRa

Lum Mun Meng

2nd



1st



6 / 9 / 2 5 5 5

TV ● พนักงานขับรถ

ชั้นโถงหน้า

- 3 4
- 7 8
- 11 12
- 15 16
- 19 20

TV

ชั้นโถงกลาง

- 25 26
- 29 30
- 33 34
- 37 38
- 41 42 43 44 45

- 1 2
- 5 6
- 9 10
- 13 14
- 17 18
- 21 22
- 23 24
- 27 28
- 31 32
- 35 36
- 39 40

ชั้นล่าง

TV



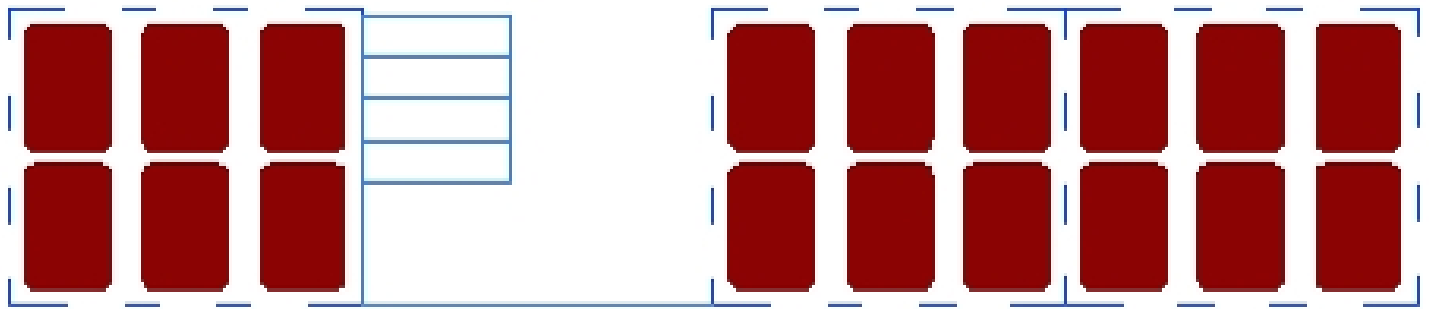
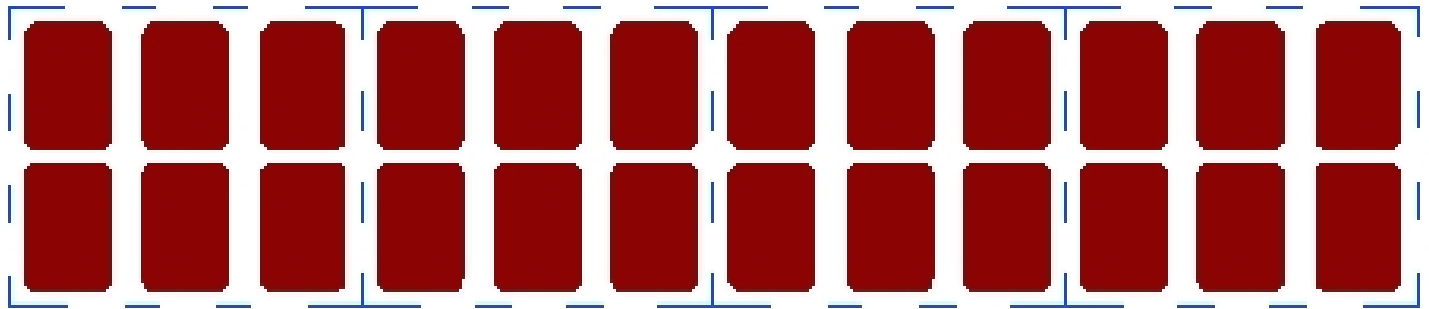

Plan 2nd

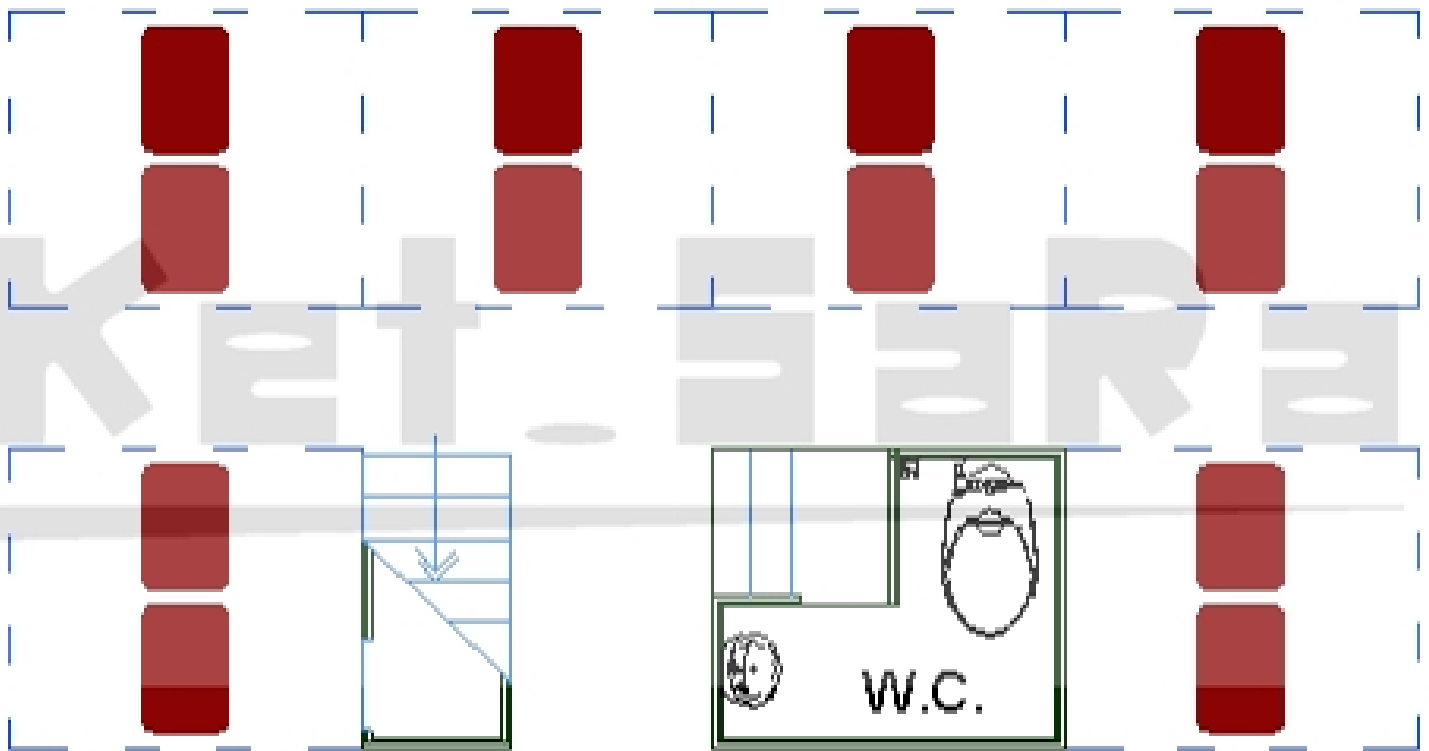

6 / 9 / 2 5 5 5

Plan 1st

เขียงเลื่อยชนิด

7/9/2555

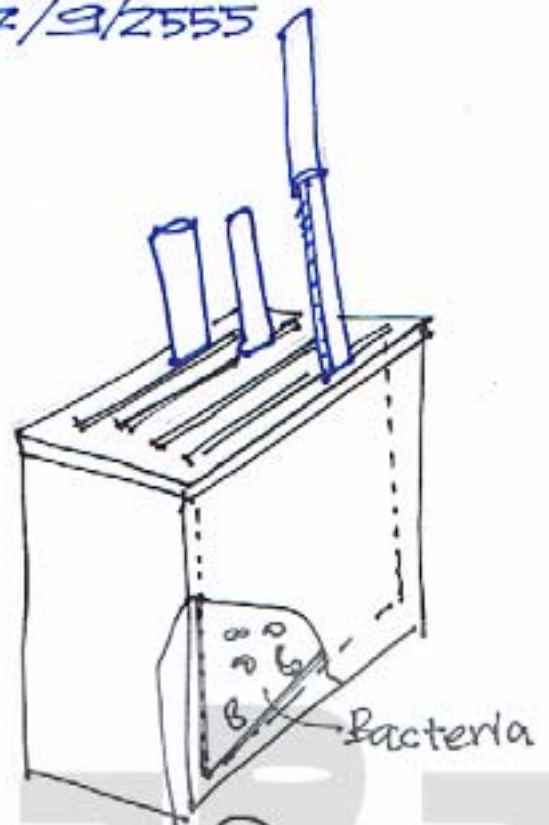
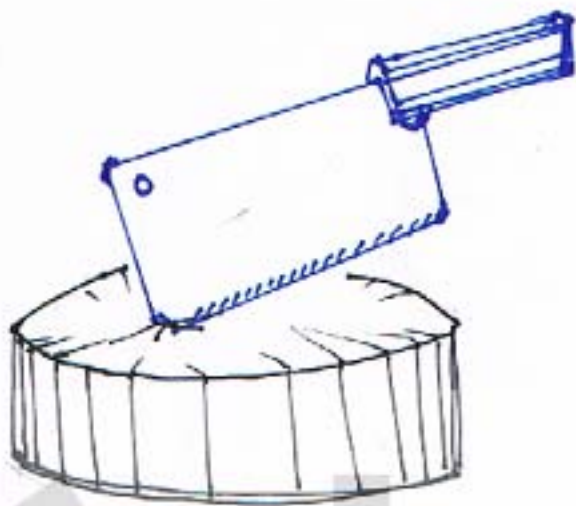

washing

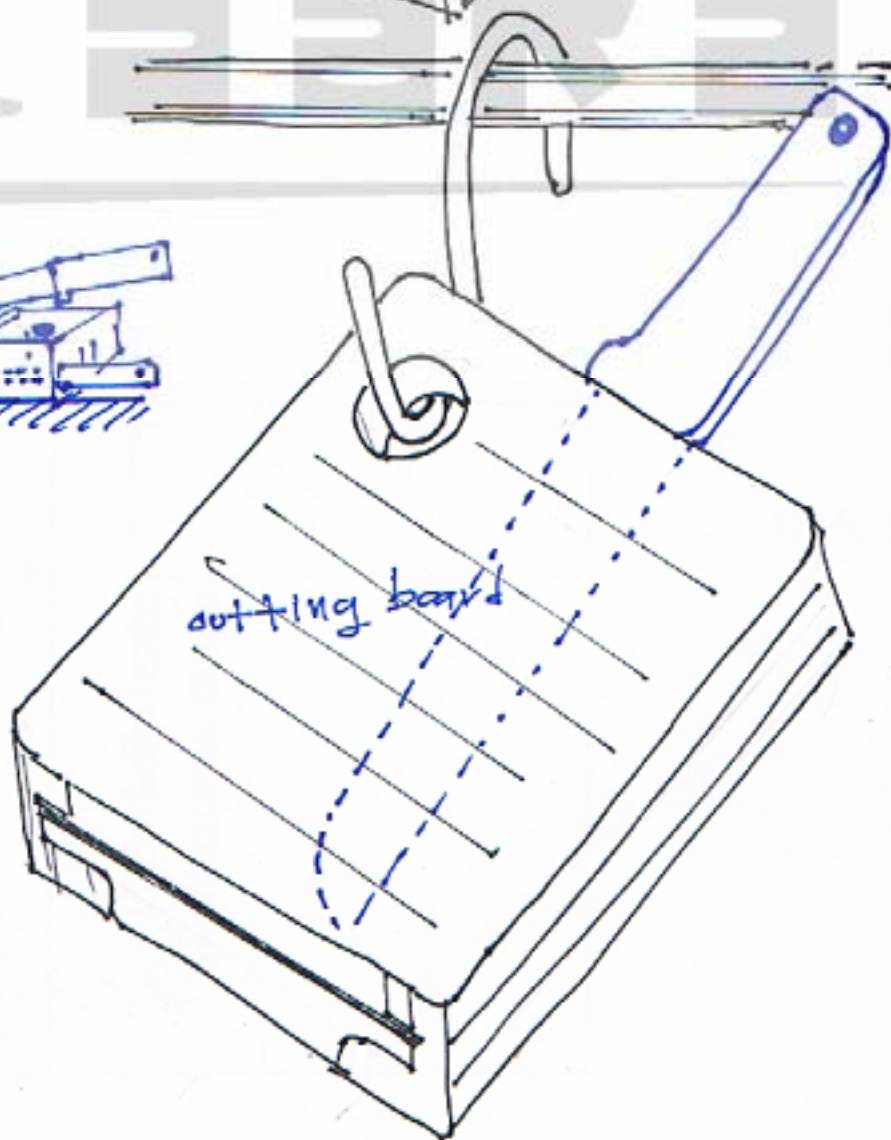
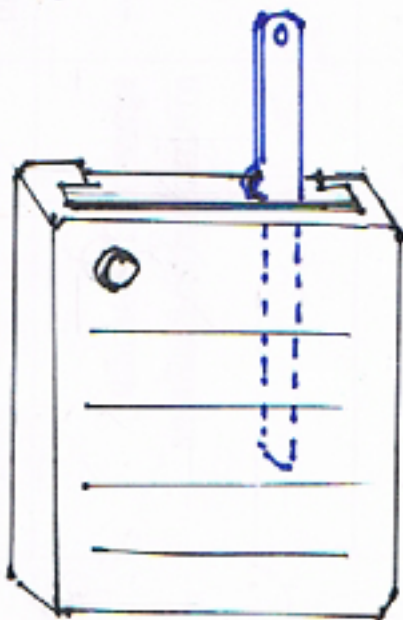
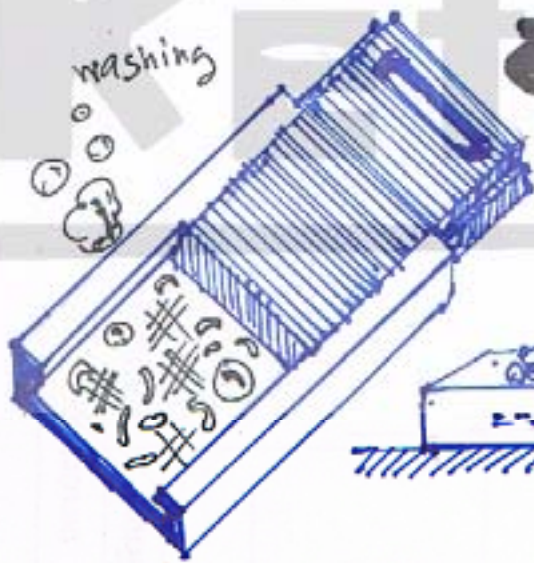

เตียงปลูก

8/9/2555

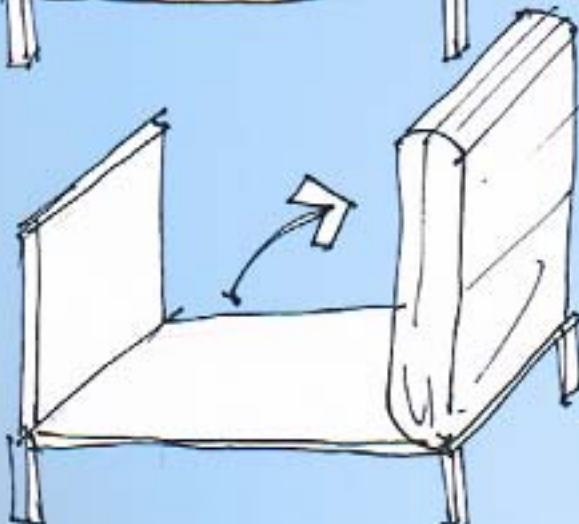

Wooden Soap Mold + Soap Cutter

天田木工

06/05/2012



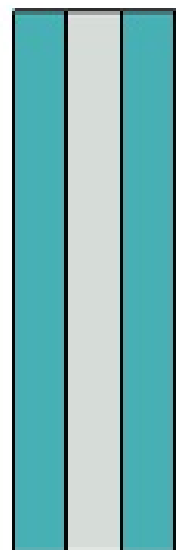
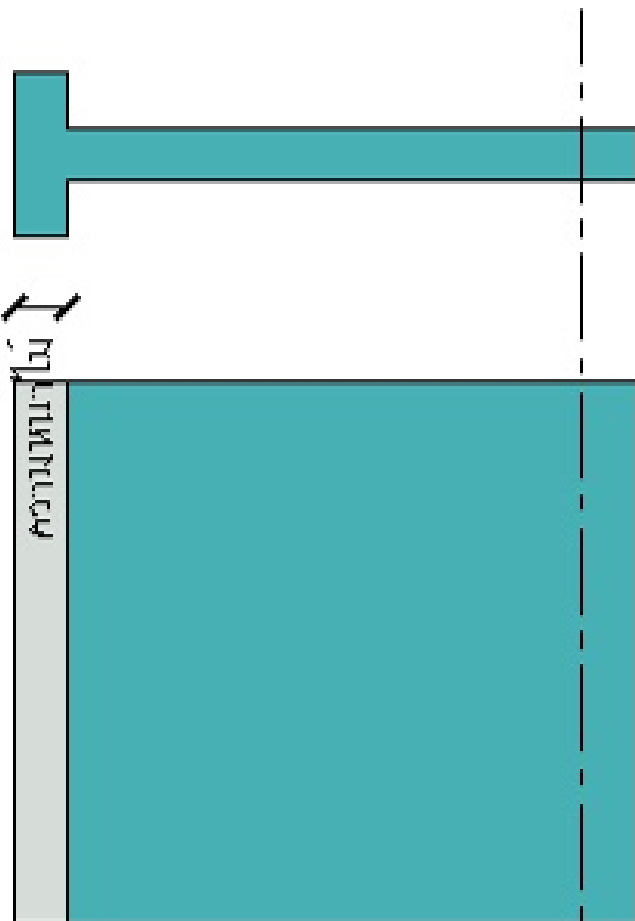

ประมาณ 30 หรือ 40

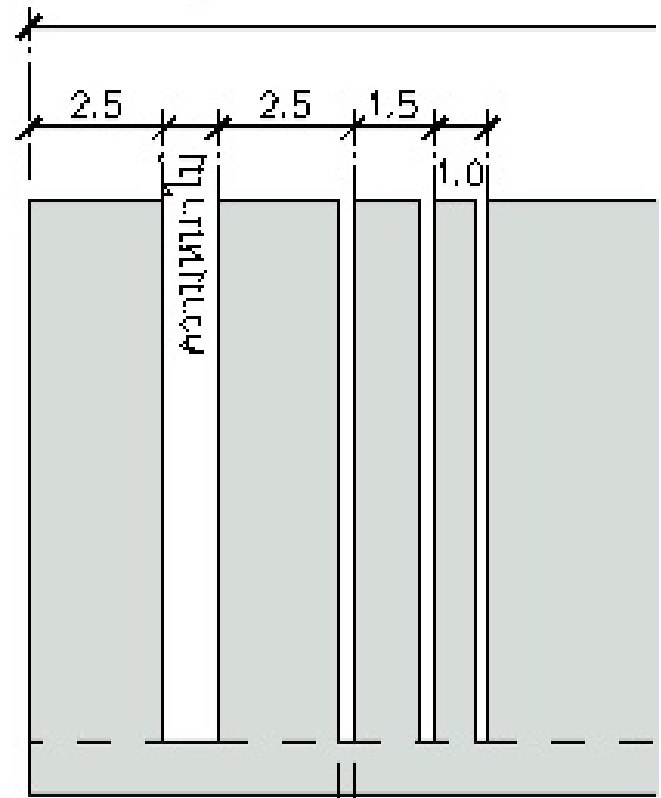
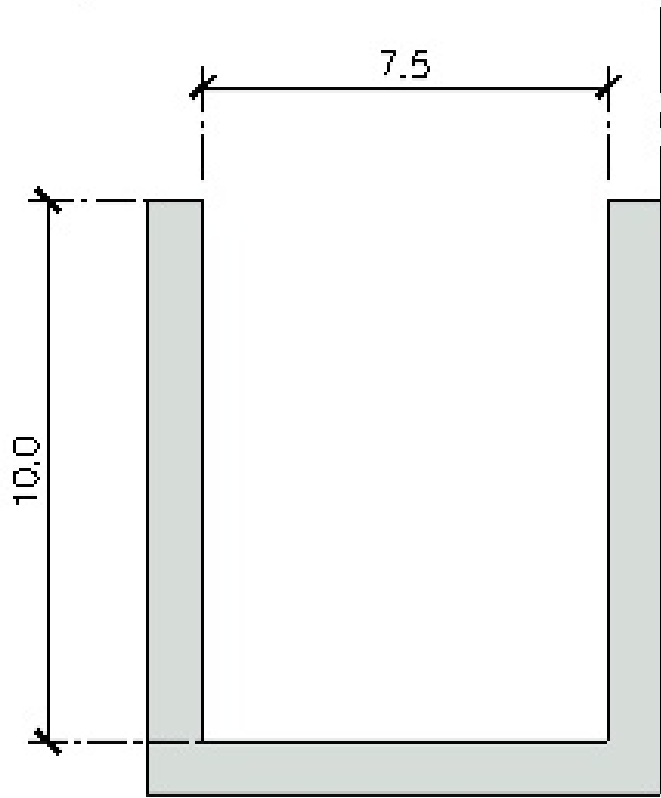

บากร่องแคบสุด โบริดผ่านได้

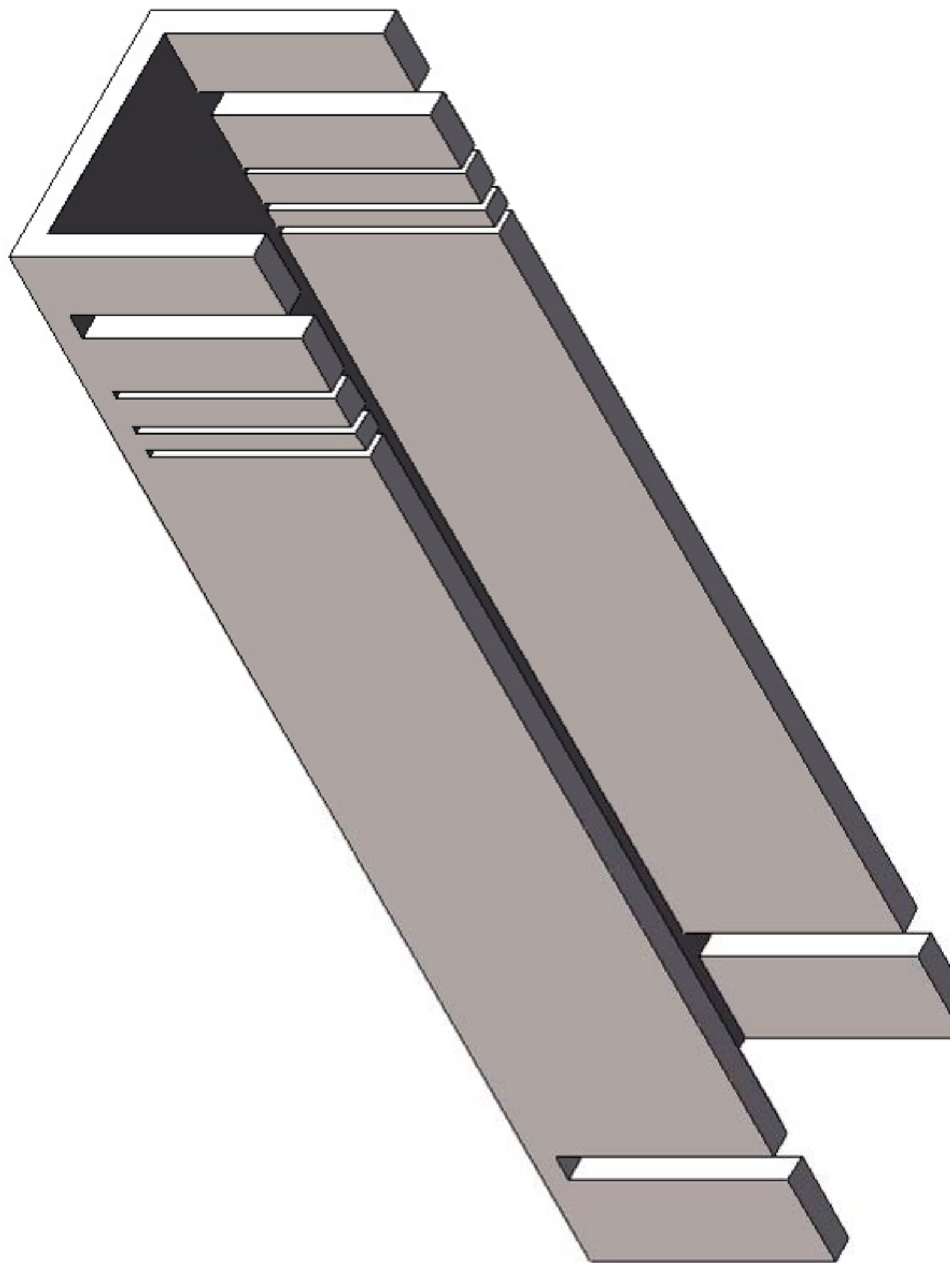

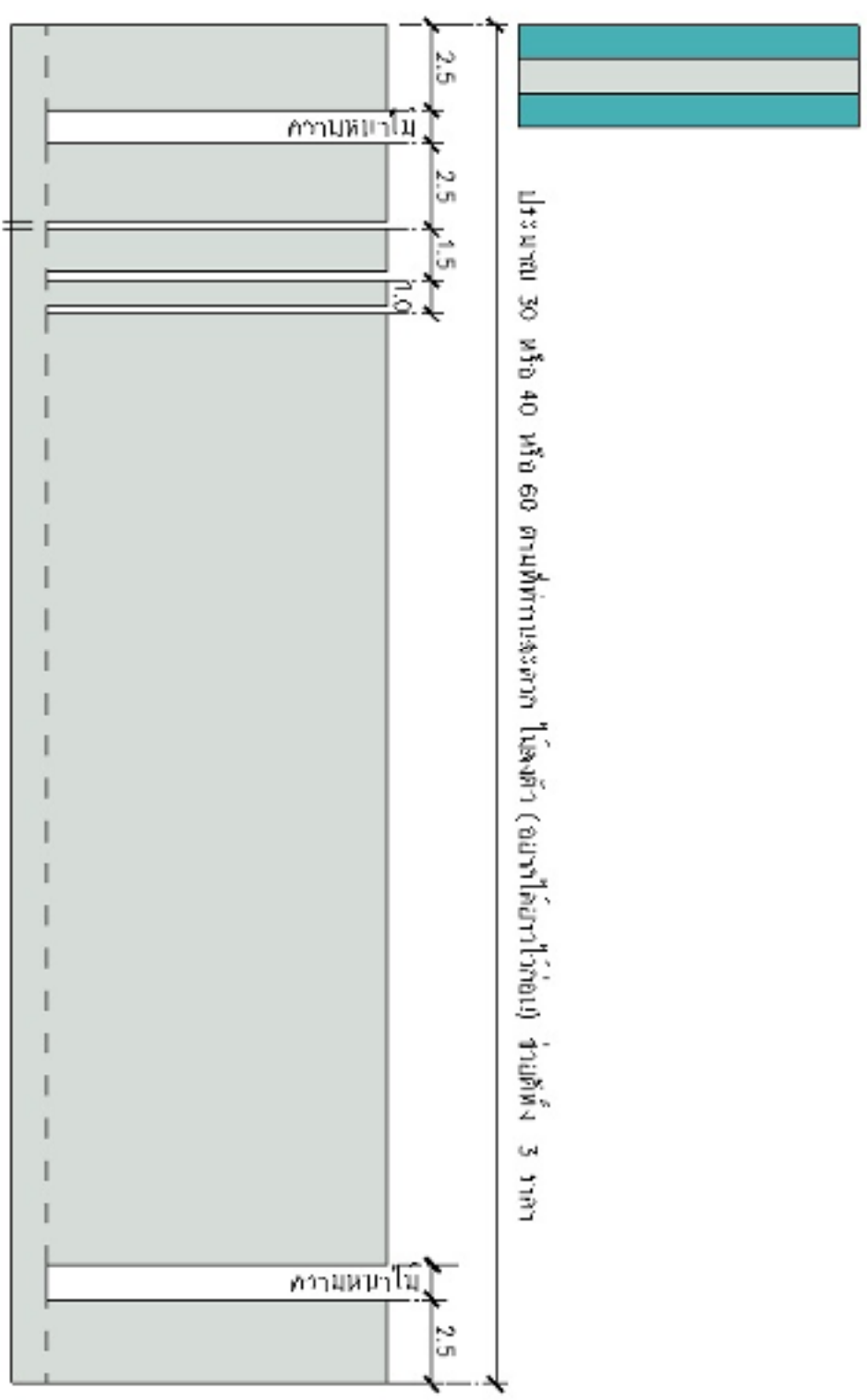
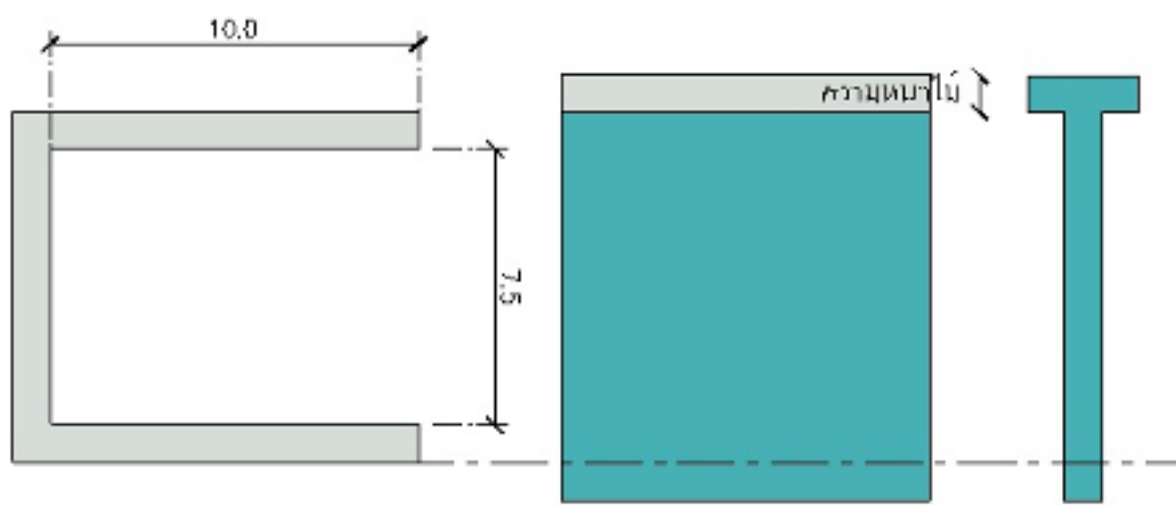

ขนาดความสูง ไม้อัดที่เลือกใช้

ขนาดความสูง 30 หรือ 40 หรือ 60 ตามที่ผู้ทำแบบเลือก ใช้ไม้ (เลือกไม้ที่ไว้ก่อน) จำนวน 3 ท่อน

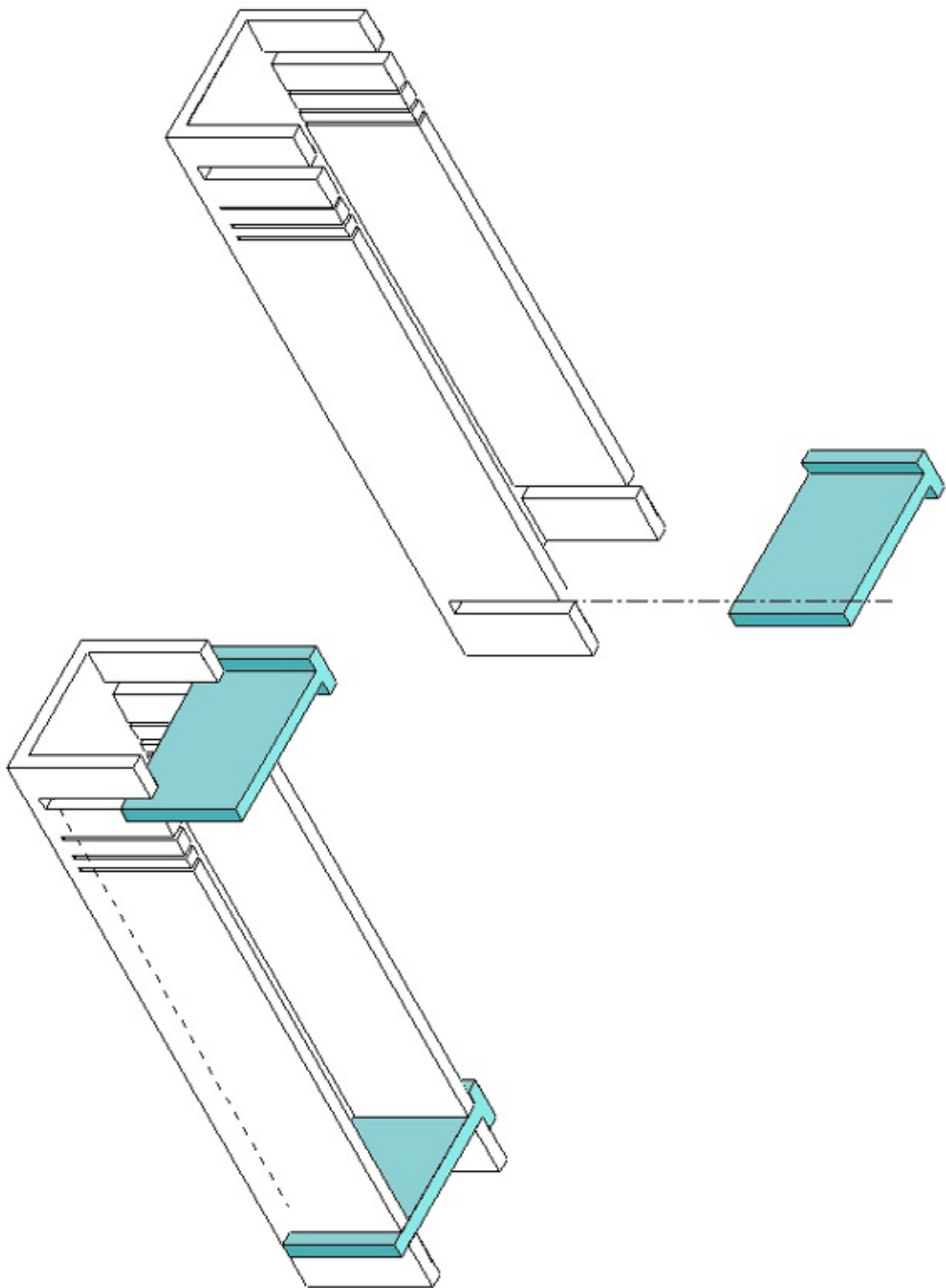

ตู้หิ้วหนังสือ

Concept

10/9/2555

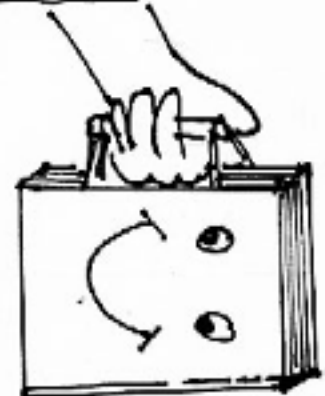
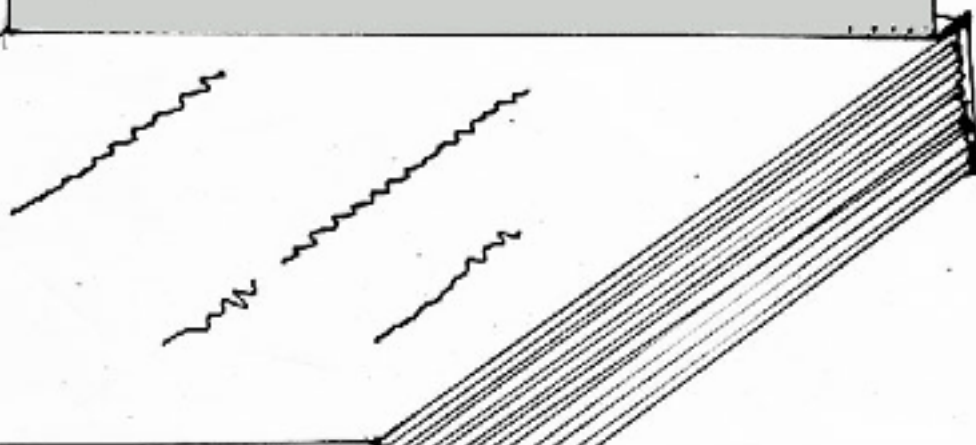
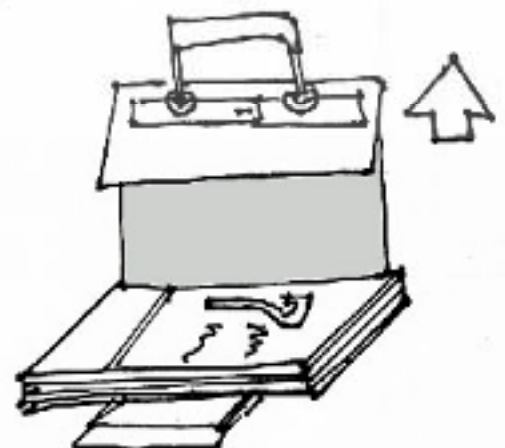
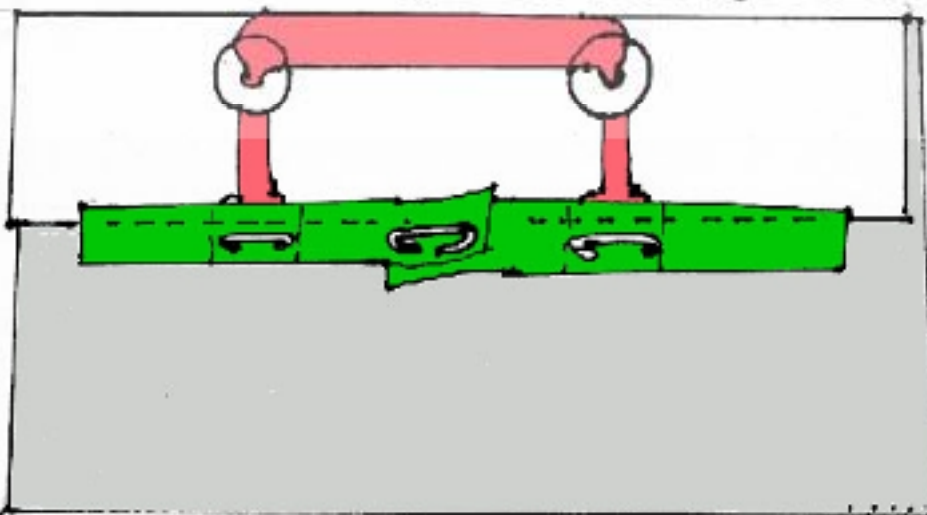
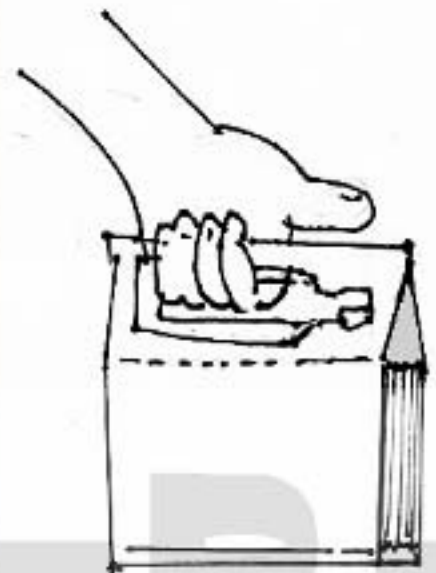
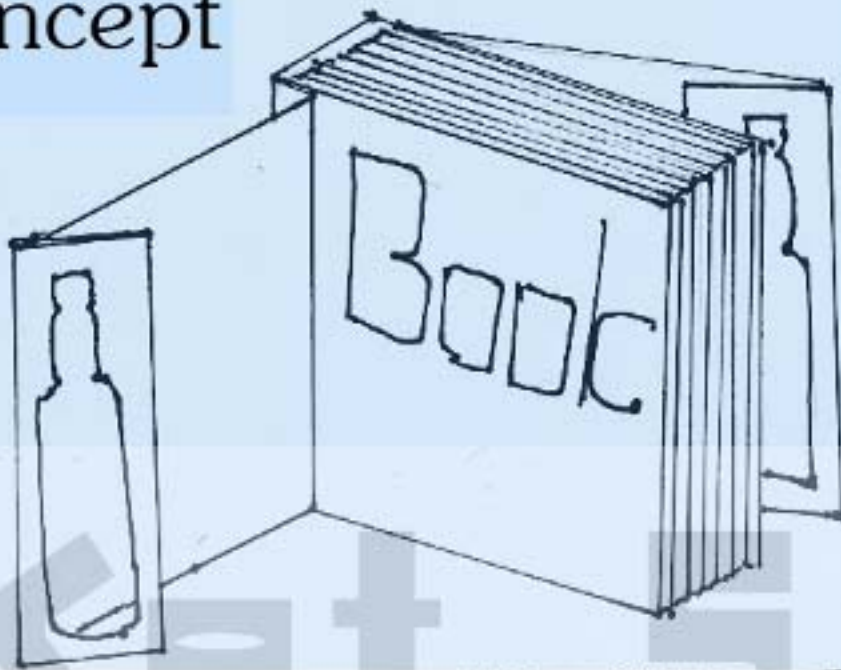

A.

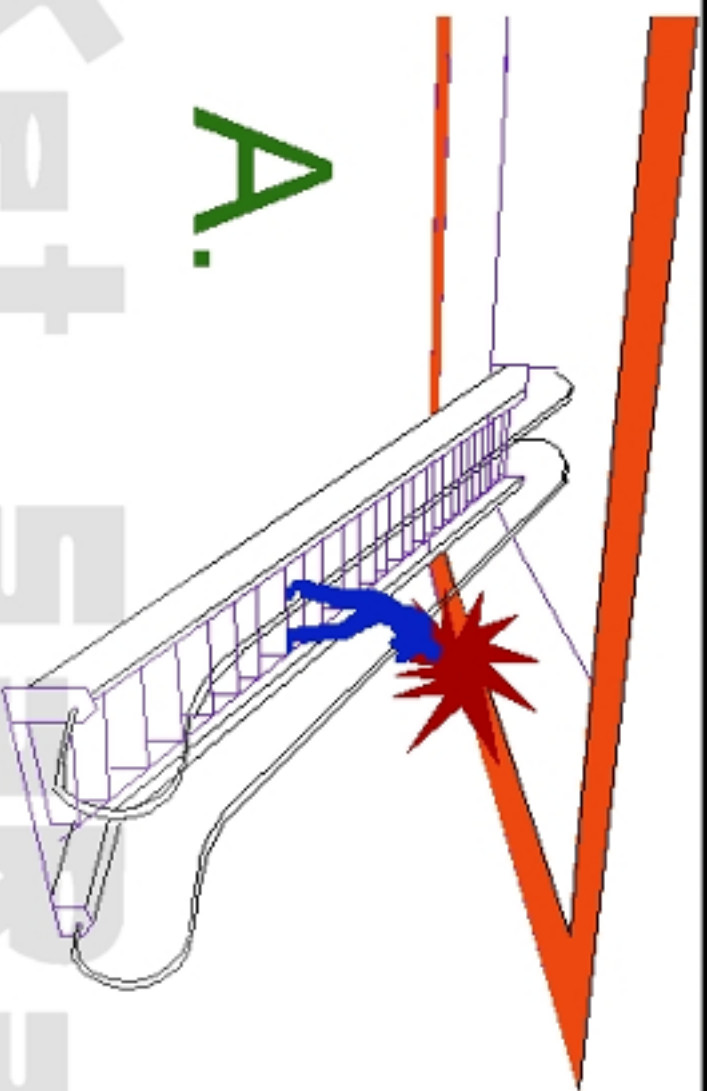

B.

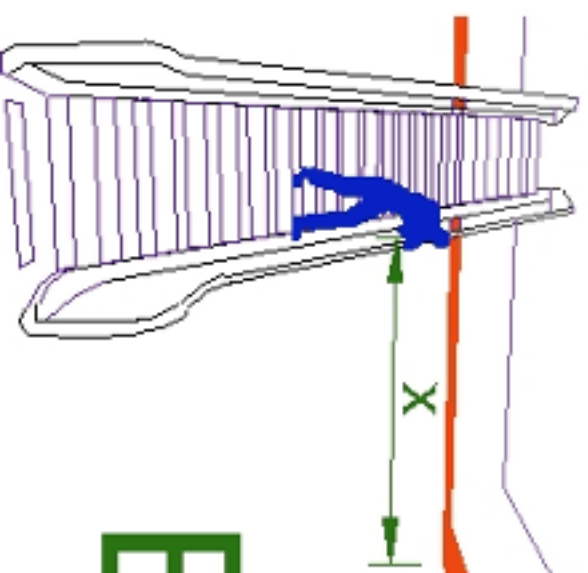

A.

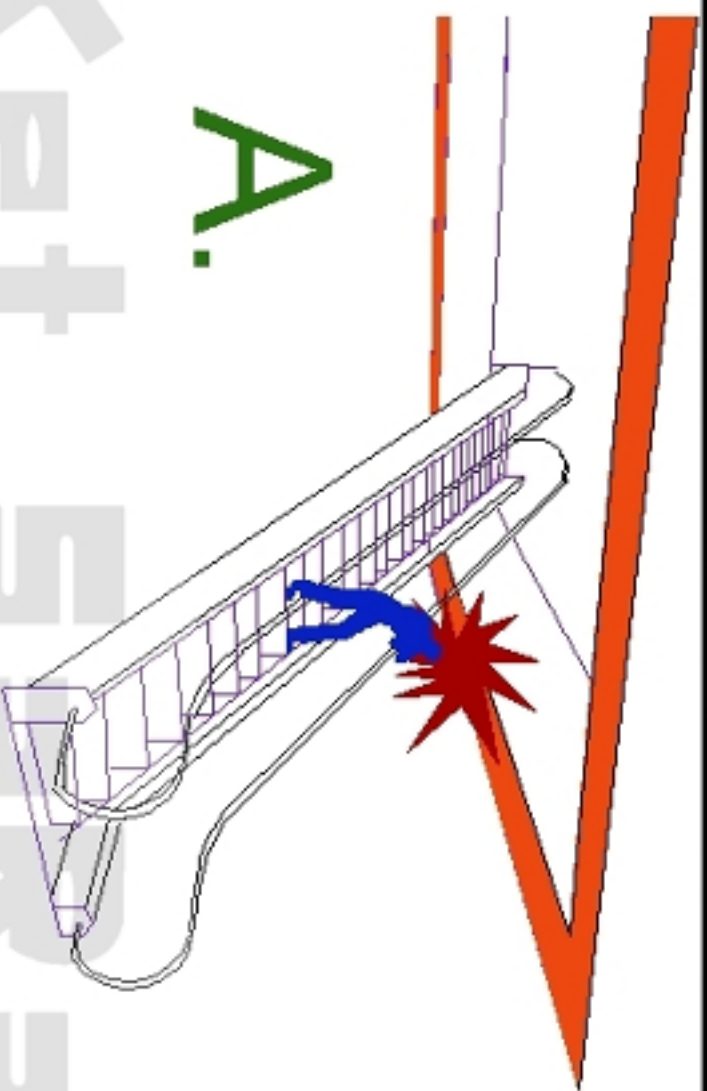

B.

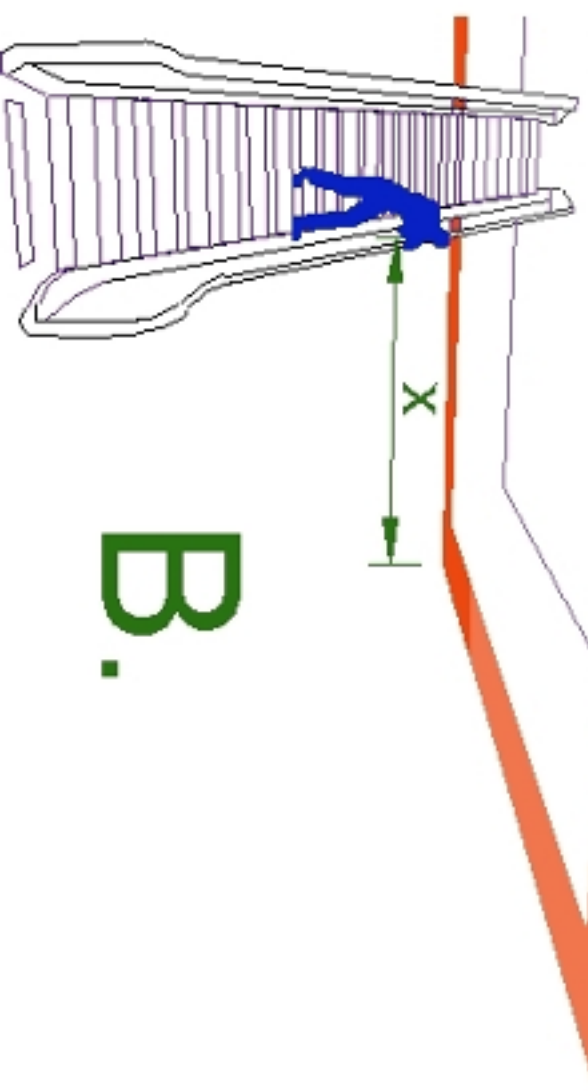

กัมปนาทไดเลชั่น

12/9/2555

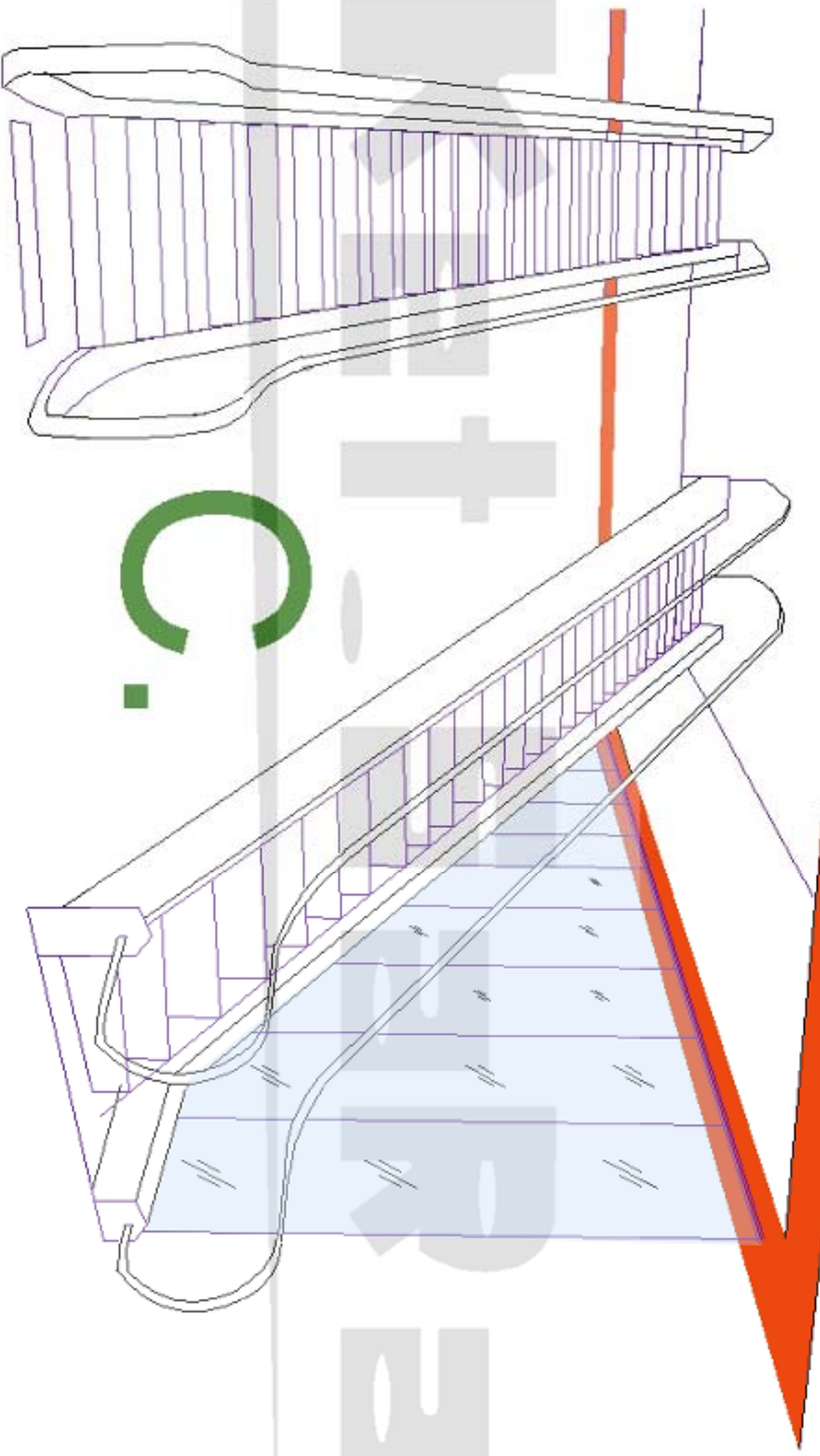

กัมปนาทไดเล็คตรอน

12/9/2555

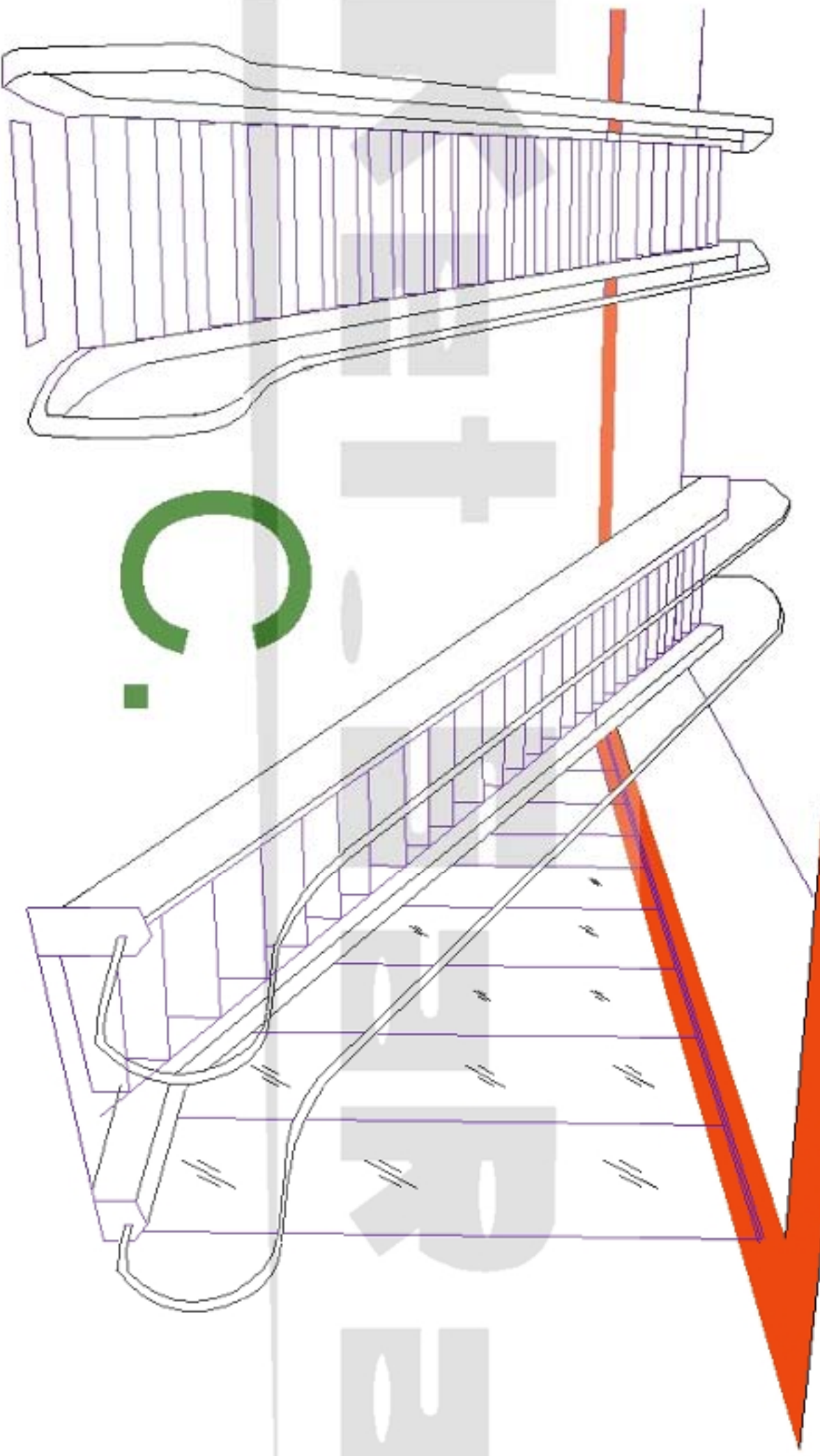

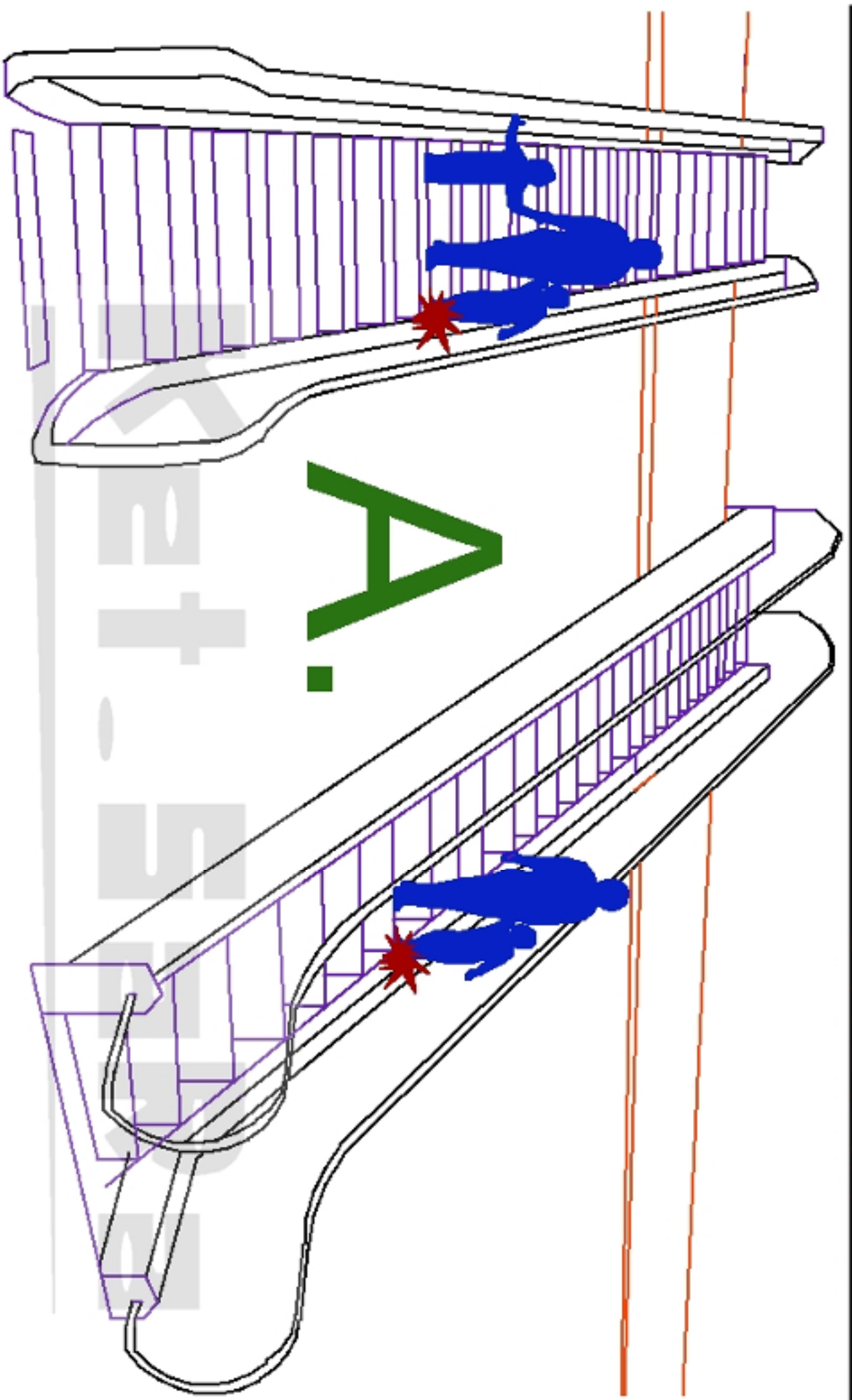

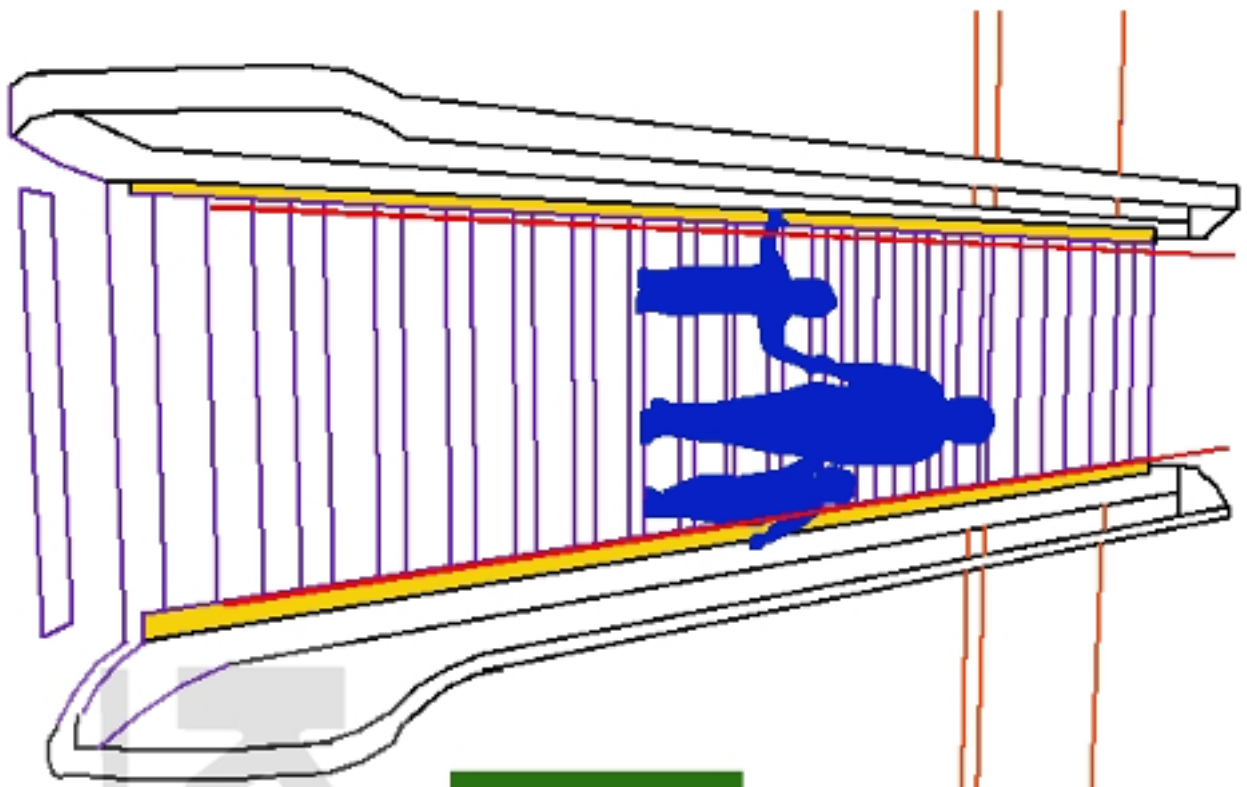

B.

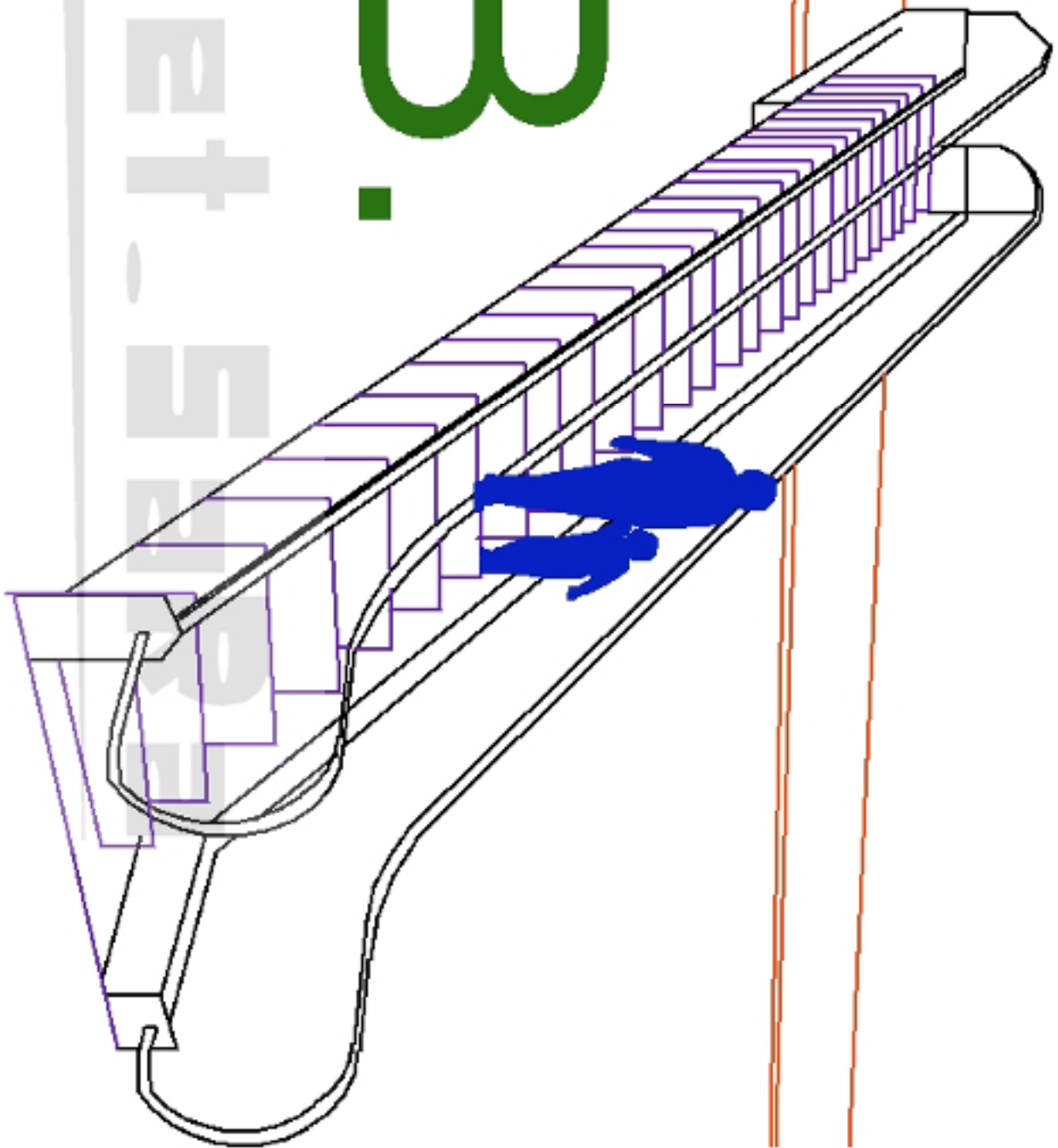

ถุงกระดาษ A4 ,A3

11/9/2555

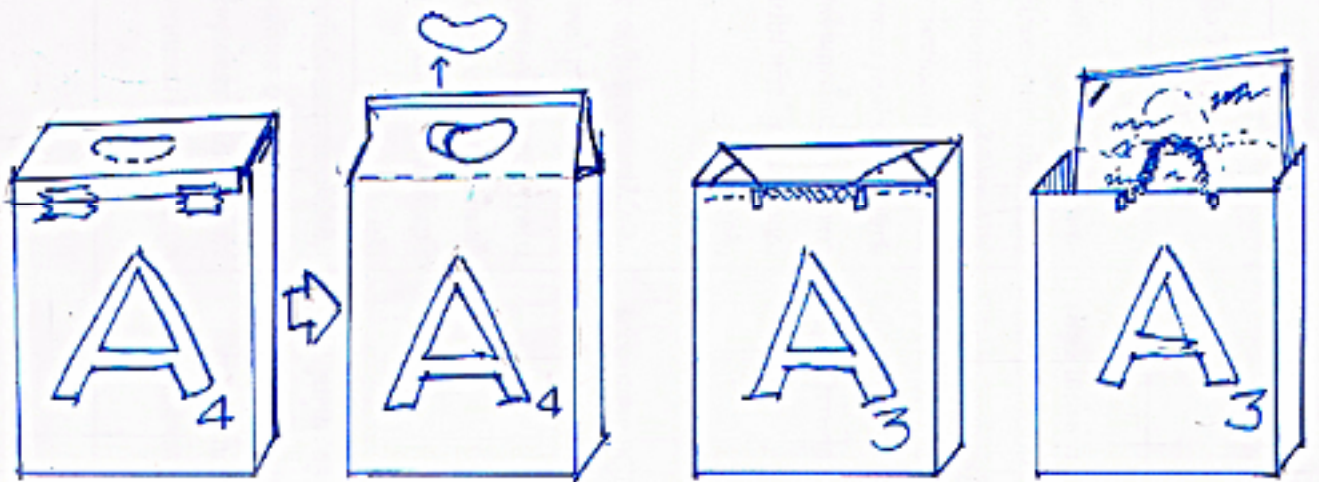
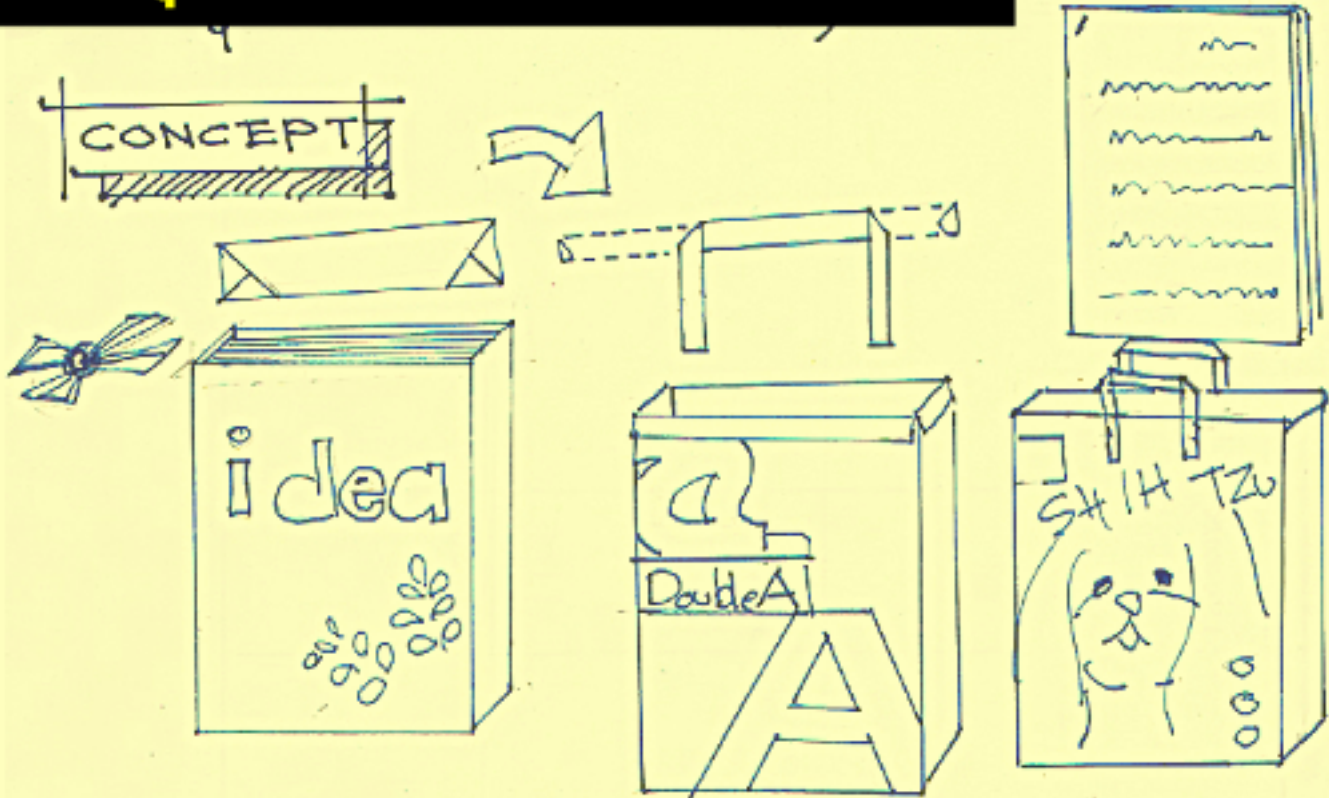

Ket. SaRa

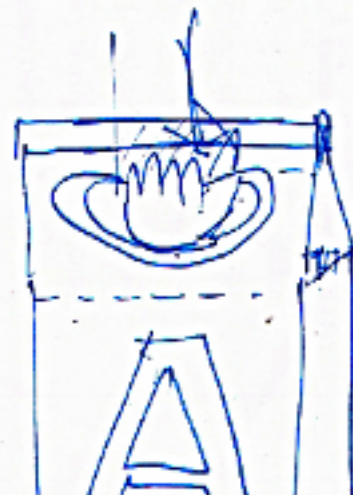

กระชอนปลาเหลือน้ำ

14/9/2555

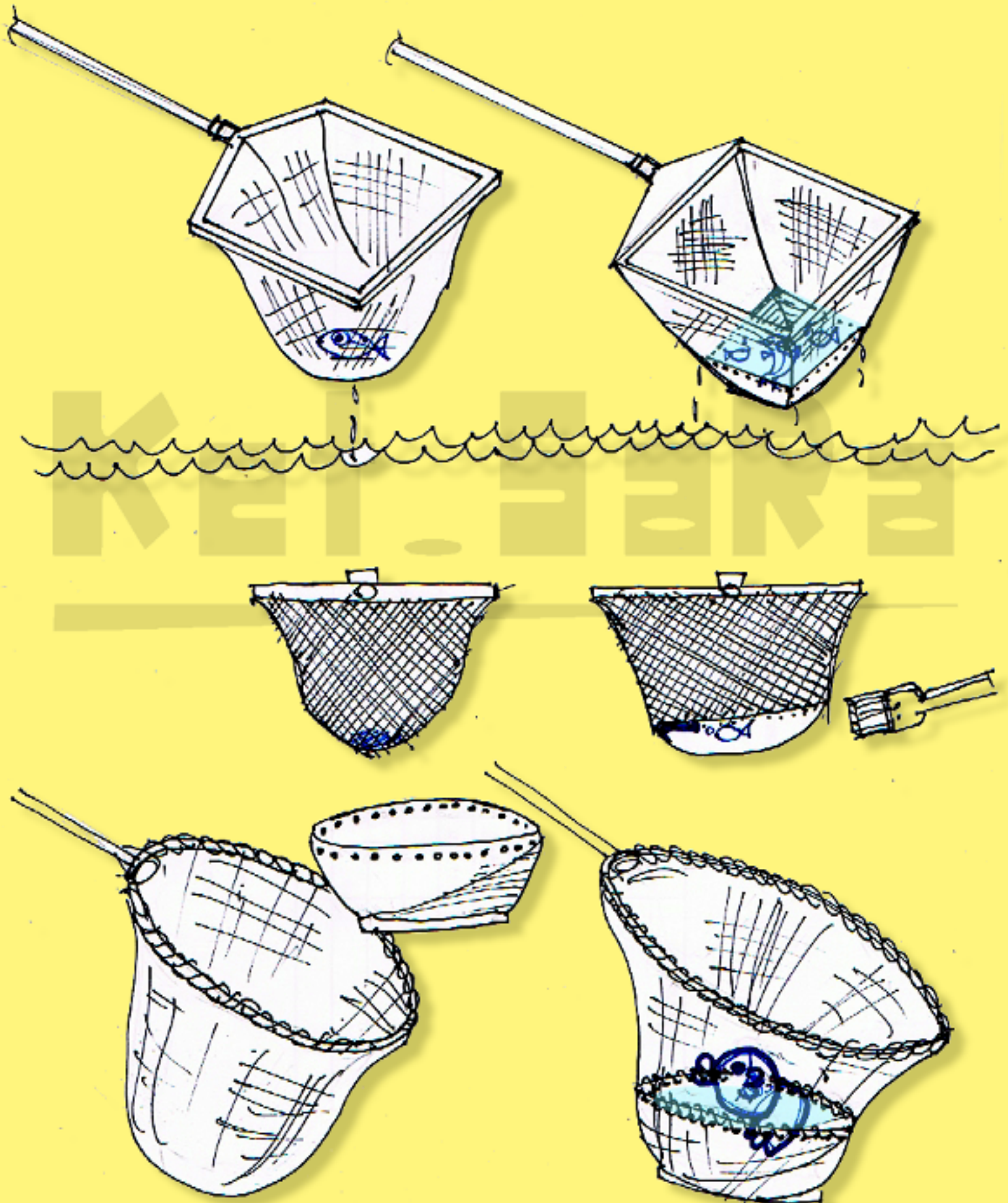

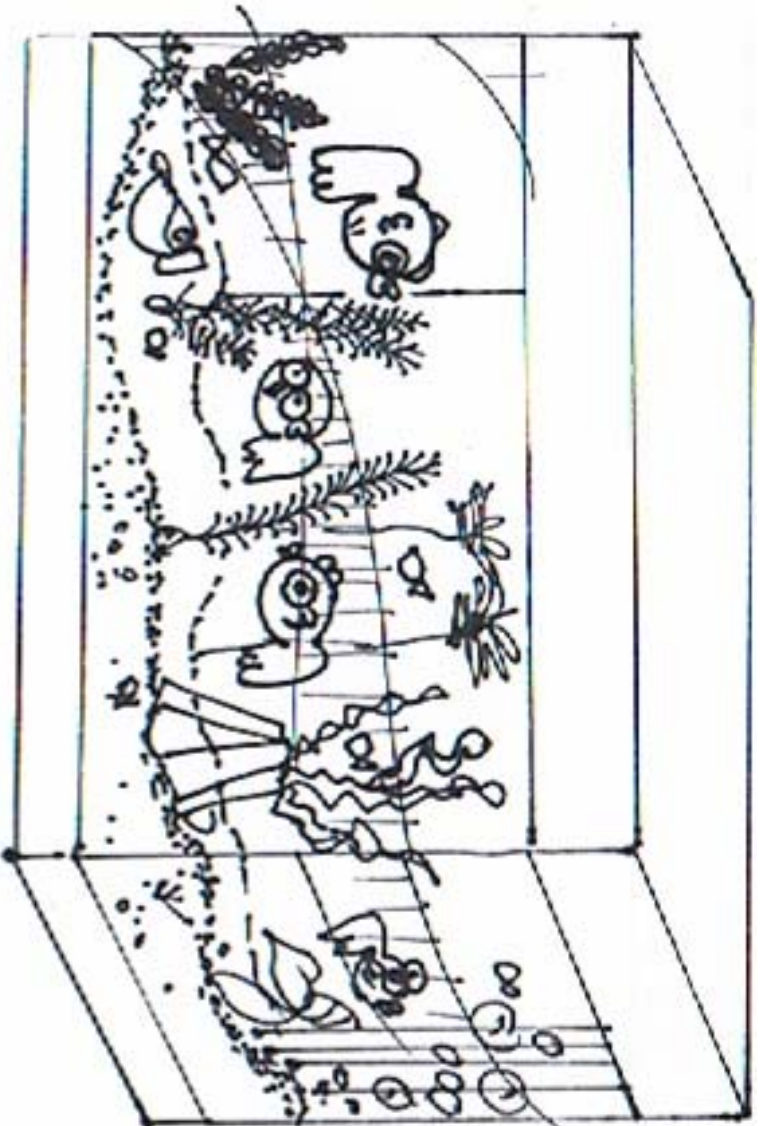

ត្រីប្រតិទិន

14/9/2555

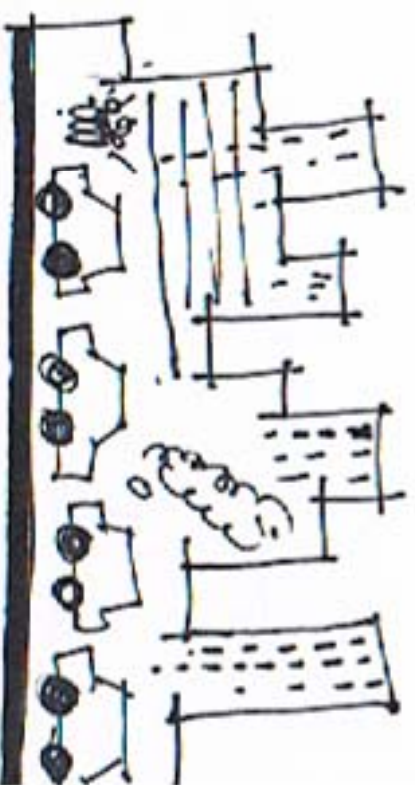
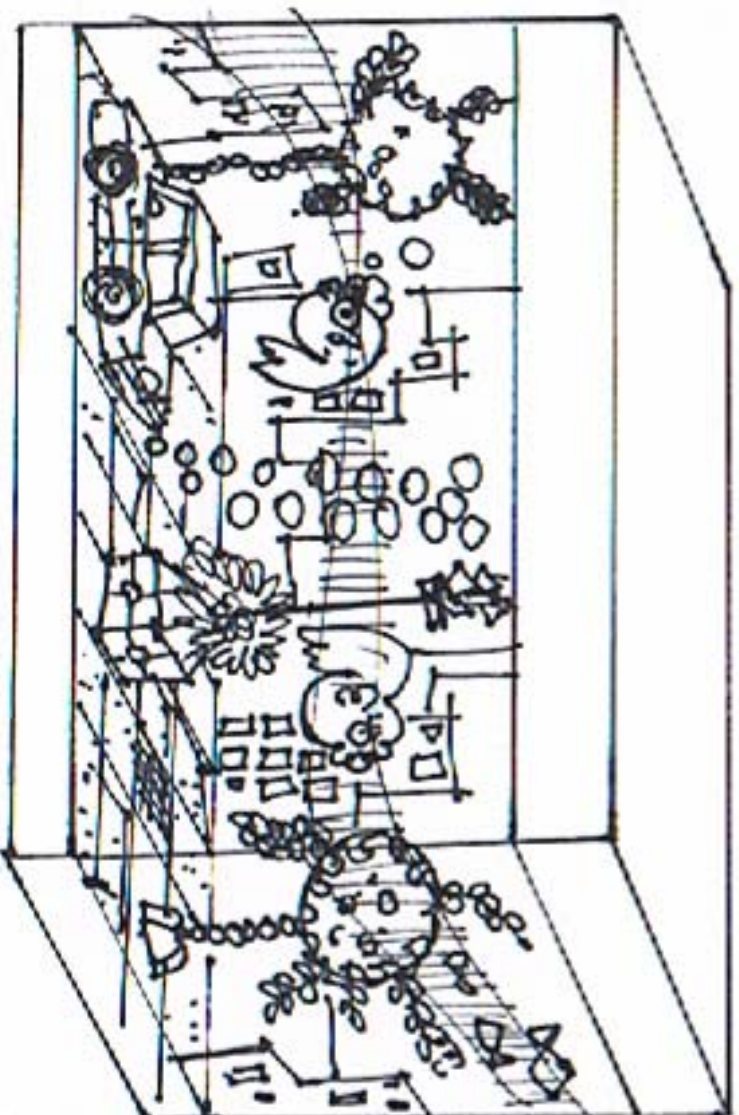

คอนโตนโตปลา กัด

15/9/2555



ตุ้ม
น้ำ
ช่าง
กล้า

16/9/2555

Ket_SaRa

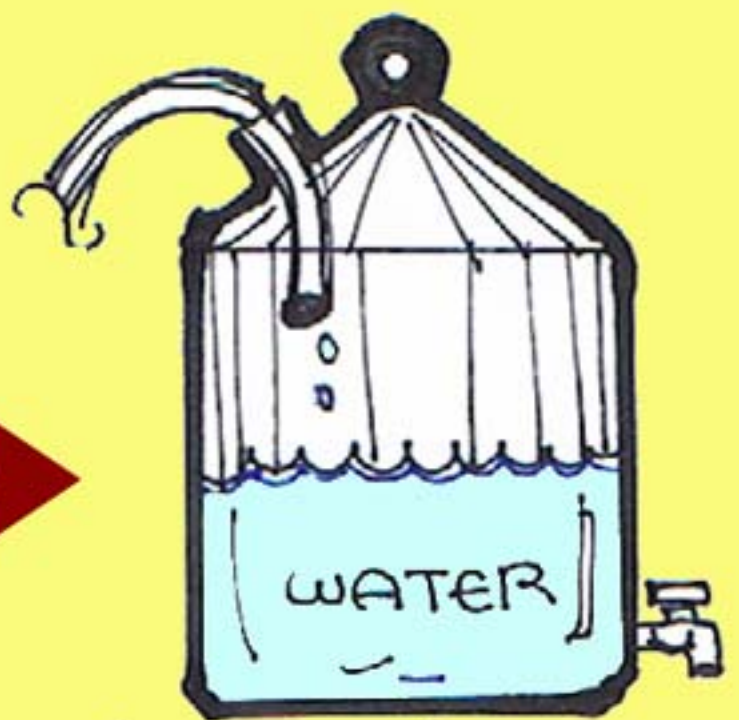
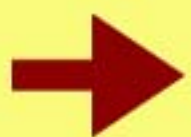
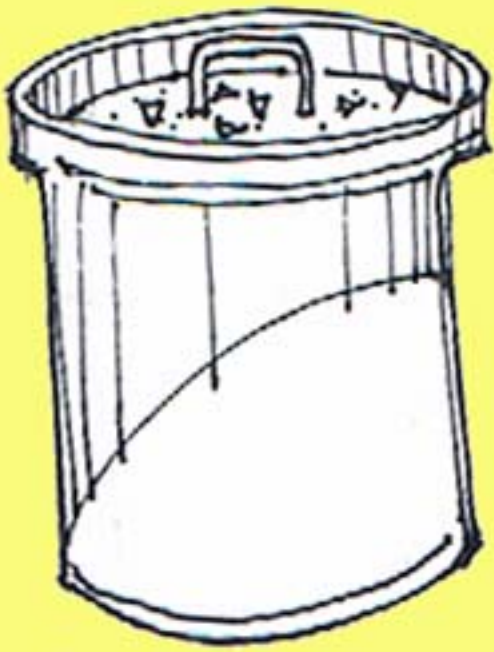
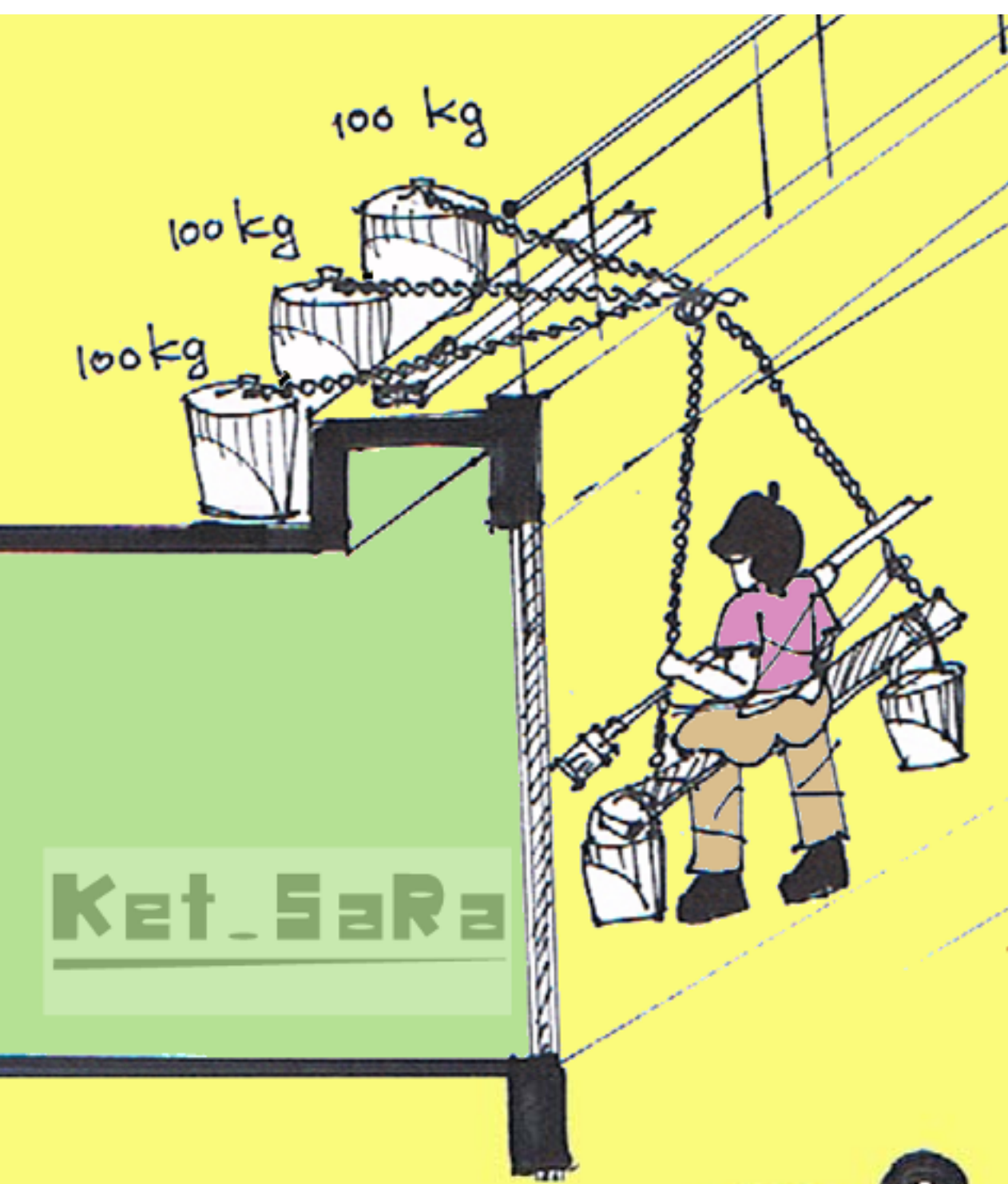

Ket-SARA

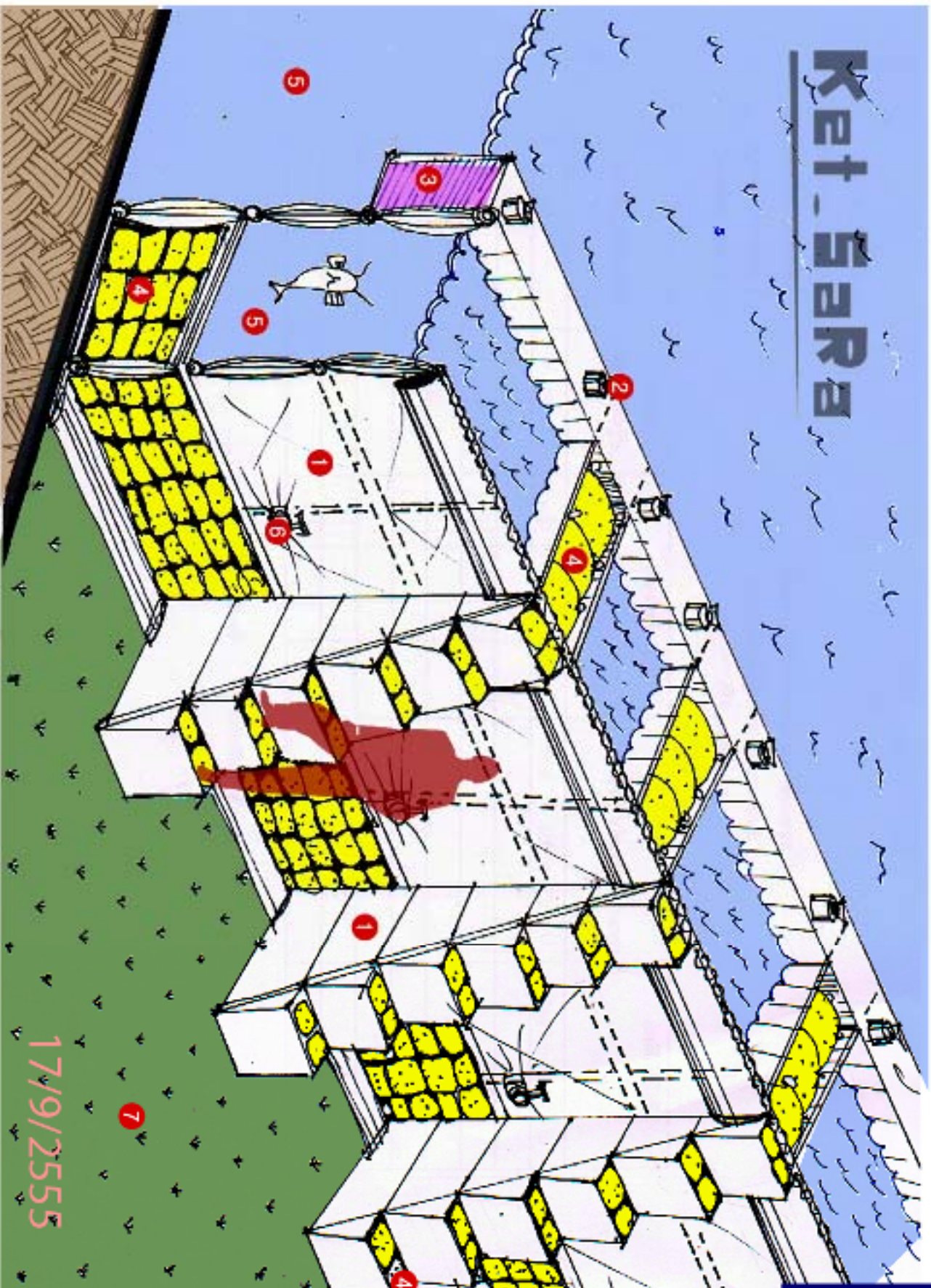

น้ำจืดน้ำ

1. ผ้าใบ
2. จุกฉีด PU โฟม
3. PU โฟม
4. ถังทราย
5. น้ำ
6. ประตูระบายน้ำ
7. พื้นที่ปลอดภัย

ภาพแทน :

แบ่งดูทรายตรงกลางไม่กรอง
เนื่องจากคนเขียนตำรา

17/9/2555

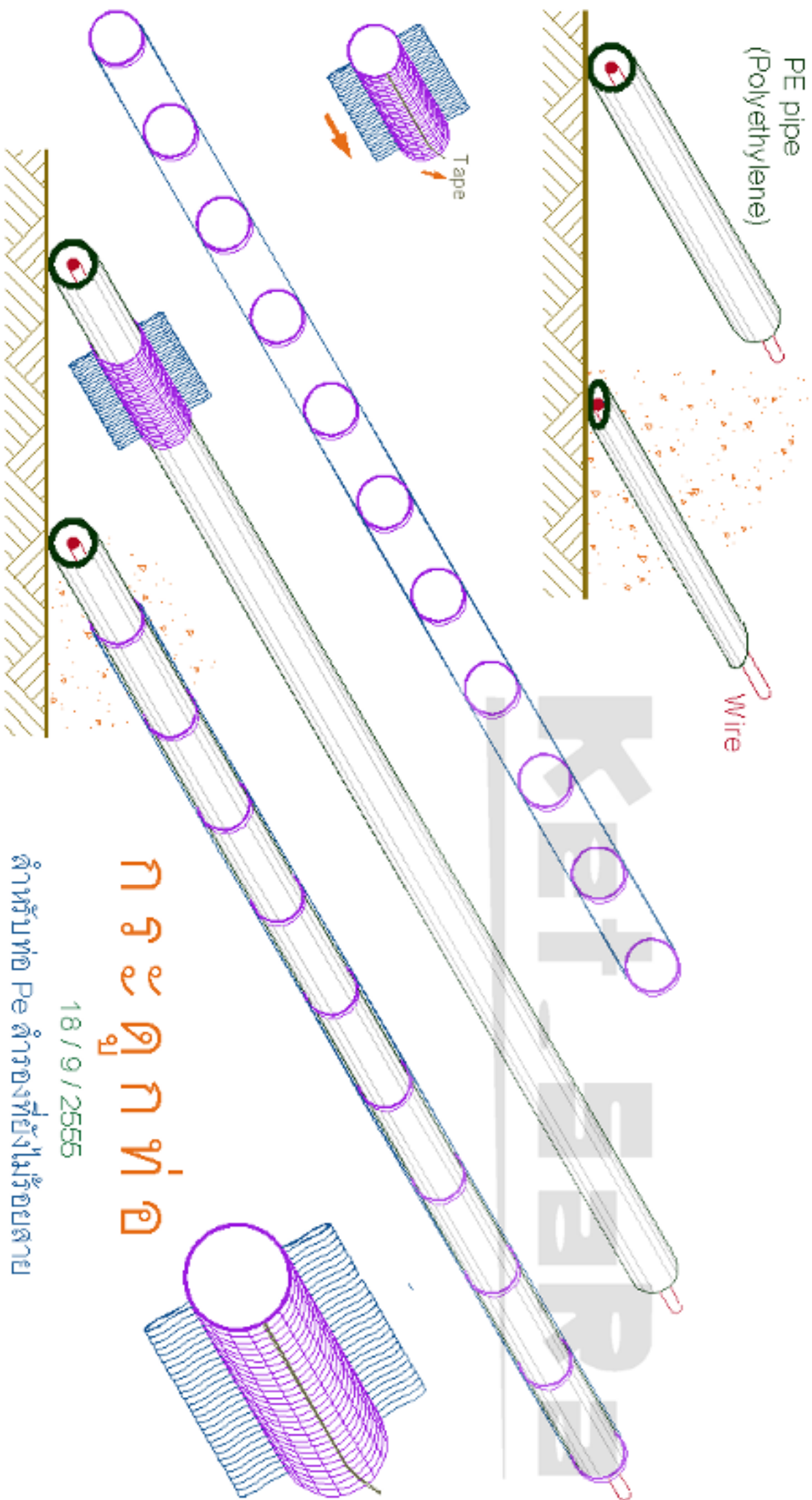

การติดตั้งท่อ

18/9/2555

สำหรับท่อ Pe สำหรับที่ยังไม่ร้อยสาย

KET - BAR



Concept

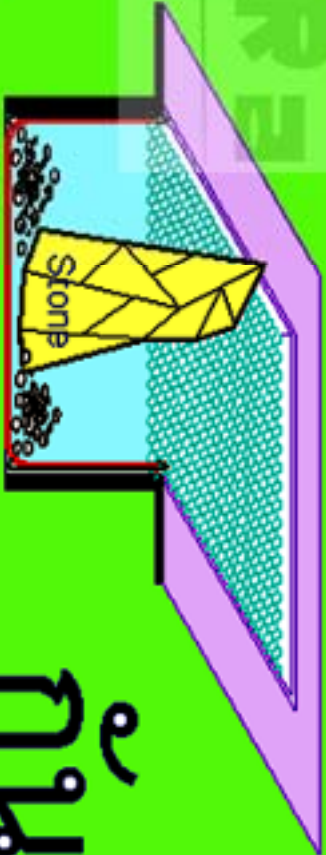
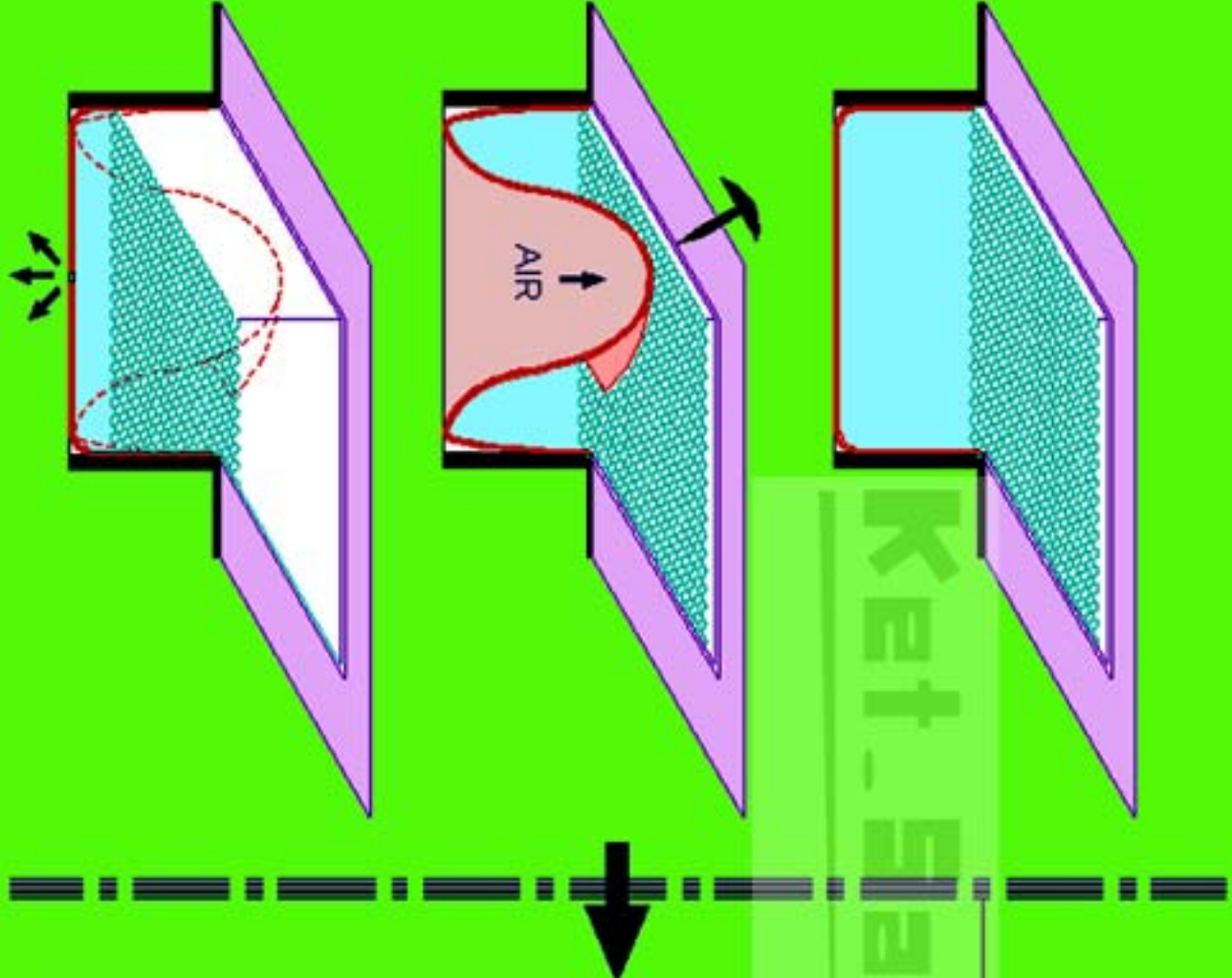

กันไพลิ่ง

19/9/2555

